

Types H, H15, H16, H3, MH 24 + 7, MH 21 + 5

Page

Technical characteristics type H .....

**04.10**

Type H15 connectors .....

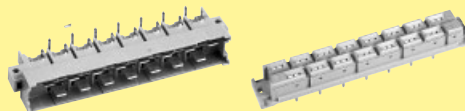

**04.11**

Type H16 connectors .....

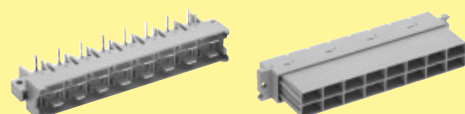

**04.16**

Type H3 connectors .....



**04.17**

Technical characteristics type MH .....

**04.20**

Type MH 24 + 7 connectors .....

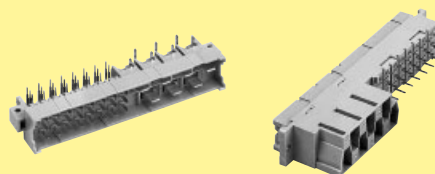

**04.22**

Type MH 21 + 5 connectors .....

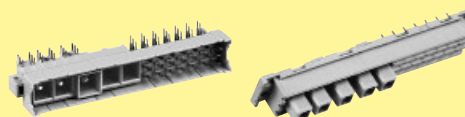

**04.24**

**Number of contacts**  
 15, 16  
 14 + 1 leading contact  
 (position z 32)  
 13 + 2 leading contacts  
 (position z 4 und z 32)  
 3

**Working current** 15 A max.  
 see current carrying capacity chart

**Clearance** Type H15:  $\geq 4.5$  mm  
 Type H3:  $\geq 4.0$  mm

**Creepage** Type H15:  $\geq 8.0$  mm  
 Type H3:  $\geq 3.7$  mm

**Working voltage**  
 The working voltage also depends on the clearance and creepage dimensions of the pcb itself and the associated wiring according to the safety regulations of the equipment Explanations see chapter 00  
 Connectors should not be mated under voltage

**Test voltage  $U_{r.m.s.}$**  Type H15:  $\geq 3.1$  kV  
 Type H3:  $\geq 2.5$  kV

**Contact resistance**  $\leq 8$  m $\Omega$

**Insulation resistance**  $\geq 10^{12}$   $\Omega$  for standard articles  
 $\geq 10^{11}$   $\Omega$  for special NFF articles (with part-no. ending 222)

**Temperature range** - 55 °C ... + 125 °C  
 The higher temperature limit includes the local ambient and heating effects of the contacts under load

**Electrical termination**  
 Connector with faston 6.3 x 2.5 (faston blade width x wire gauge) according to DIN 46 245 and DIN 46 247  
 Solder pins for pcb connections  $\varnothing 1.6 \pm 0.1$  mm DIN EN 60 097  
 Cage clamp terminal 0.14-1.5 mm<sup>2</sup>

**Insertion and withdrawal force**  
 Type H15:  $\leq 90$  N  
 Type H3:  $\leq 20$  N

**Materials**  
 Mouldings Thermoplastic resin, glass-fibre filled, UL 94-V0  
 Contacts Copper alloy

**Contact surface**  
 Contact zone Hard silver plated or gold plated

Mating conditions see chapter 00  
 Coding systems see chapter 00

## Current carrying capacity

The current carrying capacity is limited by maximum temperature of materials for inserts and contacts including terminals. The current capacity curve is valid for continuous, non interrupted current loaded contacts of connectors when simultaneous power on all contacts is given, without exceeding the maximum temperature.

Control and test procedures according to DIN IEC 60 512

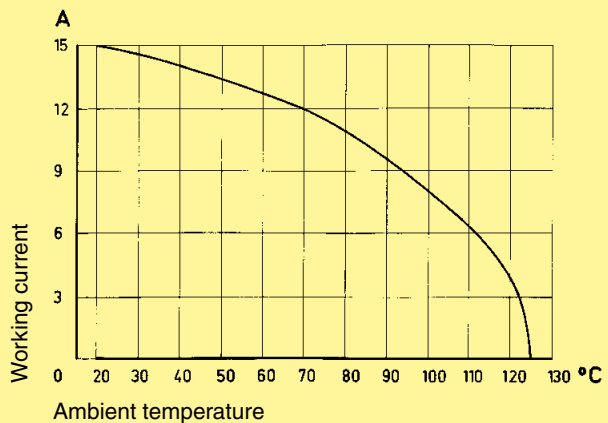

## Low currents and voltages

Type H standard contacts have a silver plated surface. This precious metal has excellent conductive properties. In the course of a contact's lifetime, the silver surface generates a black oxide layer due to its affinity to sulphur. This layer is smooth and very thin and is partly interrupted when the contacts are mated and unmated, thus guaranteeing very low contact resistances. In the case of very low currents or voltages small changes to the transmitted signal may be encountered. This is illustrated below where an artificially aged contact representing a twenty year life is compared with a new contact.

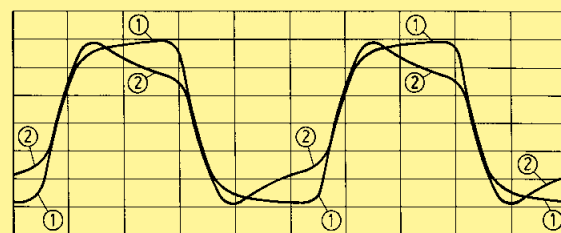

Changes to the transmitted signal after artificial ageing  
 ① new contact ② after ageing

In systems where such a change to the transmitted signal could lead to faulty functions and also in extremely aggressive environments, HARTING recommend the use of gold plated contacts.

Below is a table derived from actual experiences.

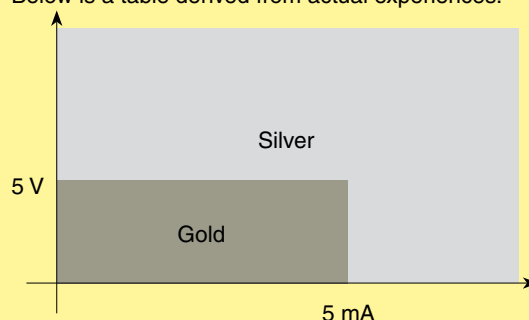

Recommendation

Number of contacts

# 15

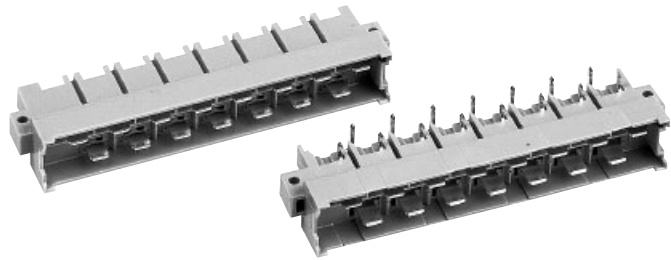

Male connectors

Identification	Number of contacts	Part No.	Drawing	Dimensions in mm
Male connector for faston 6.3 x 2.5	15	Performance level 1 acc. to IEC 60603-2 09 06 015 2912 <sup>1)</sup>	<p>Contact arrangement View from termination side</p> <p>Board drillings</p>	
1 leading contact (position z 32)	14 + 1	09 06 015 2931 <sup>1)</sup>		
2 leading contacts (position z 4 + z 32)	13 + 2	09 06 015 2922 <sup>1)</sup>		
Male connector with angled solder pins <sup>3)</sup>	15	09 06 115 2911 <sup>1)</sup> 09 06 115 2911 222 <sup>1)</sup>	<p>Contact arrangement View from termination side</p> <p>Board drillings</p>	
1 leading contact (position z 32)	14 + 1	09 06 115 2932 <sup>1)</sup> 09 06 115 2932 222 <sup>1)</sup>		
2 leading contacts (position z 4 + z 32)	13 + 2	09 06 115 2921 <sup>1)</sup> 09 06 115 2991 <sup>2)</sup>		
Male connector with straight solder pins	15	09 06 015 2913 <sup>1)</sup>	<p>Contact arrangement View from termination side</p> <p>Board drillings</p>	
1 leading contact (position z 32)	14 + 1	09 06 015 2914 <sup>1)</sup>		

DIN Power up to 15 A

<sup>1)</sup> Variant with silver plated contacts  
<sup>2)</sup> Variant with gold plated contacts  
<sup>3)</sup> With shroud coding, see chapter 00

<sup>0)</sup> Railway classification NFF 16-101, Smoke index: F1, Flammability class: I2

Number of contacts

15

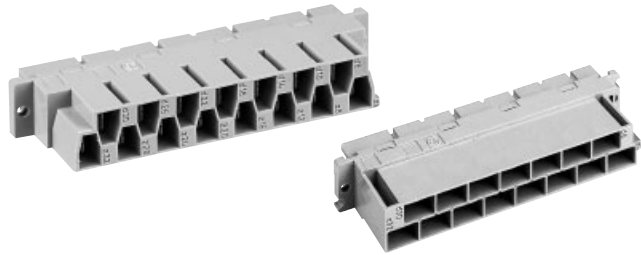

Female connectors

Identification	Number of contacts	Part No.	Drawing	Dimensions in mm
<p>Female connector for faston 6.3 x 2.5<sup>1)</sup></p> <p>Cannot be used in a shell housing</p>	15	<p>Performance level 1 acc. to IEC 60603-2</p> <p>09 06 215 2811</p>	<p>84,9</p> <p>10,1</p> <p>21</p> <p>84</p> <p>14 x 5,08 = 71,12</p> <p>6d 4z</p> <p>5,08</p> <p>90</p> <p>95max.</p> <p>12,4</p> <p>2,9</p> <p>6,3 x 0,8</p> <p>8,17</p> <p>6,5</p> <p>2,8</p> <p>0,3</p> <p>4,8</p> <p>71</p> <p>0,2</p> <p>Contact arrangement View from termination side</p> <p>..X"</p> <p>..X"</p> <p>Z32</p>	
<p>Female connector for faston 6.3 x 2.5<sup>1)</sup></p> <p>May be used in a shell housing</p>	15 15	<p>09 06 215 2871</p> <p>09 06 215 2871 222<sup>1)</sup></p>	<p>84,9</p> <p>10,1</p> <p>21</p> <p>84,5</p> <p>14 x 5,08 = 71,12</p> <p>6d 4z</p> <p>5,08</p> <p>90</p> <p>95max.</p> <p>12,4</p> <p>2,9</p> <p>6,3 x 0,8</p> <p>8,17</p> <p>6,5</p> <p>2,8</p> <p>0,3</p> <p>4,8</p> <p>71</p> <p>0,2</p> <p>Contact arrangement View from termination side</p> <p>..X"</p> <p>..X"</p> <p>D30</p> <p>Z32</p> <p>32 30 28 26 24 22 20 18 16 14 12 10 8 6 4</p>	<p>Shell housing see chapter 20</p>
Panel cut out			<p>M2,5 / 2,8</p> <p>85</p> <p>90 ± 0,1</p> <p>95,5</p> <p>7,5</p> <p>15,5</p> <p>7,5</p> <p>15,2</p>	

DIN Power up to 15 A

<sup>1)</sup> With shroud coding, see chapter 00  
<sup>1)</sup> Railway classification NFF 16-101, Smoke index: F1, Flammability class: I2

Number of contacts

15

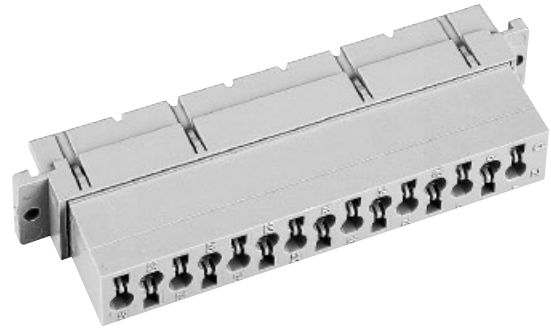

Female connectors

Identification	Number of contacts	Part No.	Drawing	Dimensions in mm
----------------	--------------------	----------	---------	------------------

Female connector with cage clamp  
May be used in a shell housing

15

Performance level 1 acc. to IEC 60 603-2

09 06 015 2813<sup>1)</sup>

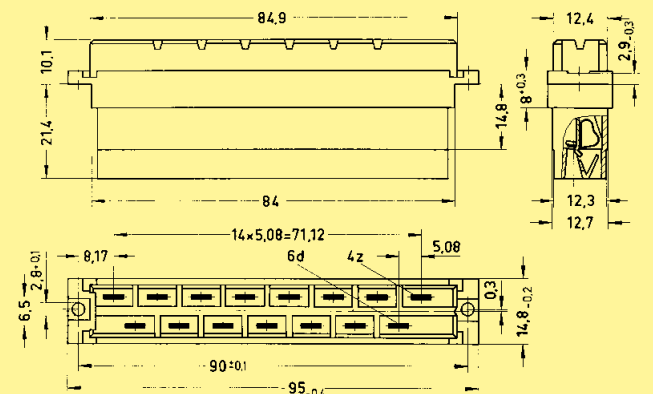

Contact arrangement View from termination side  
Slot for screw driver

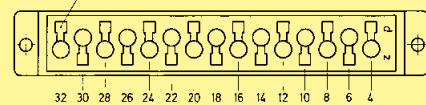

Shell housing see chapter 20

Panel cut out

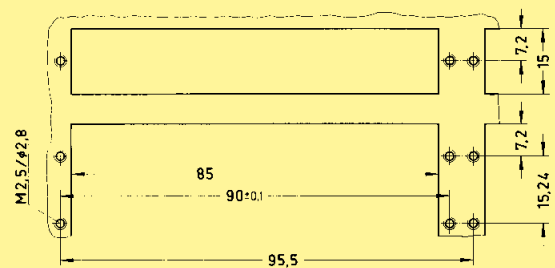

Termination instructions

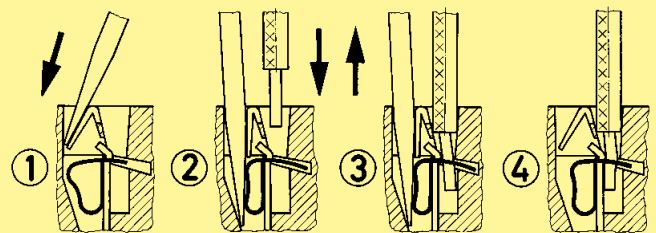

Screw driver width: 2.5 x 0.4 mm  
Stripping length: 4 - 10 mm  
Wire gauge: 0.14 - 1.5 mm<sup>2</sup> (AWG 26 - 16)

DIN Power up to 15 A

04 13

<sup>1)</sup> Railway classification NFF 16-101, Smoke index: F1, Flammability class: I2

Number of contacts

15



Female connectors

Identification	Number of contacts	Part No.	Drawing	Dimensions in mm						
Female connector "low profile" with solder pins <sup>3)</sup>		Performance level 1 acc. to IEC 60 603-2								
2.7 mm	15	09 06 215 2812 <sup>1)</sup>								
4 mm	15	09 06 215 2821 <sup>1)</sup> 09 06 215 2821 222 <sup>1)1)</sup> 09 06 215 2892 <sup>2)</sup> 09 06 215 2892 222 <sup>2)1)</sup>								
5.5 mm	15	09 06 215 2890 <sup>2)</sup>		<table border="1"> <tr><td>a</td></tr> <tr><td>2.7</td></tr> <tr><td>4</td></tr> <tr><td>5.5</td></tr> <tr><td>7</td></tr> <tr><td>10</td></tr> </table>	a	2.7	4	5.5	7	10
a										
2.7										
4										
5.5										
7										
10										
7 mm	15	09 06 215 2831 <sup>1)</sup> 09 06 215 2891 <sup>2)</sup>								
10 mm	15	09 06 215 2841 <sup>1)</sup>	<p>Contact arrangement View from termination side</p>							
Board drillings Mounting side										

DIN Power  
up to 15 A

<sup>1)</sup> Variant with silver plated contacts  
<sup>2)</sup> Variant with gold plated contacts  
<sup>3)</sup> With shroud coding, see chapter 00

<sup>1)</sup> Railway classification NFF 16-101, Smoke index: F1, Flammability class: I2

Number of contacts

15



Female connectors

Identification	Number of contacts	Part No.	Drawing	Dimensions in mm
<p>Female connector "low profile" with press-in pins 3.6 mm</p> <p>Contact space termination side 5.08 mm</p>	15	<p>Performance level 1 acc. to IEC 60 603-2</p> <p>09 06 215 2854 09 06 215 2854 222<sup>1)</sup></p>	<p>Board drillings Mounting side</p>	
<p>Contact space termination side 2.54 mm</p>	15	09 06 215 2856	<p>Board drillings Mounting side</p>	

DIN Power  
up to 15 A

04  
15

<sup>1)</sup> Refer to recommended configuration of pcb holes, see page 00.25

<sup>2)</sup> Railway classification NFF 16-101, Smoke index: F1, Flammability class: I2

Number of contacts

16

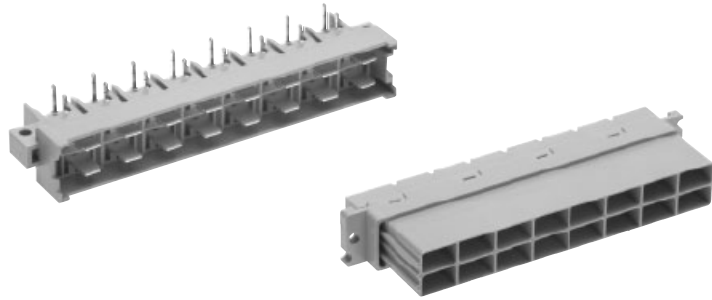

Male connectors

Identification	Number of contacts	Part No.	Drawing	Dimensions in mm
----------------	--------------------	----------	---------	------------------

Male connector with angled solder pins

Number of contacts

16

Performance level 1 acc. to IEC 60 603-2

09 06 116 2511

Drawing

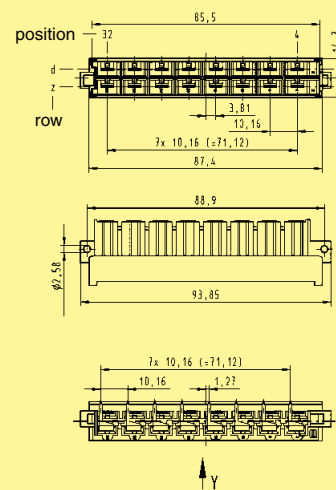

Dimensions in mm

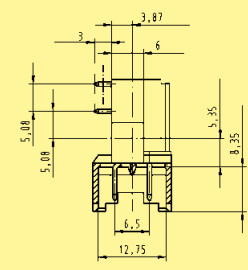

Board drillings

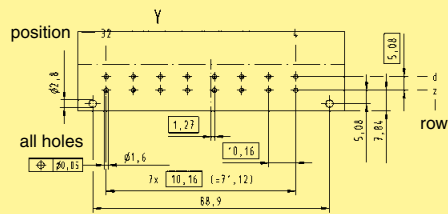

Female connector for faston 6.3 x 2.5

16

09 06 216 2411

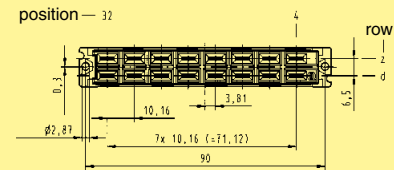
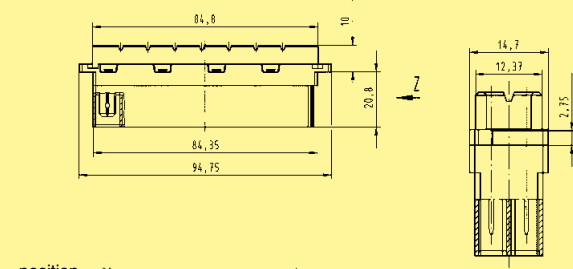



Number of contacts

# 3



Male and female connectors

Identification	Number of contacts	Part No.	Drawing	Dimensions in mm
----------------	--------------------	----------	---------	------------------

Male connector with angled solder pins and preleading middle contact

3

Performance level 1 acc. to IEC 60603-2

09 06 203 2911

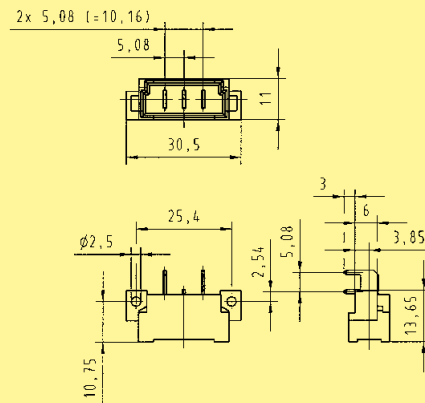

Board drillings

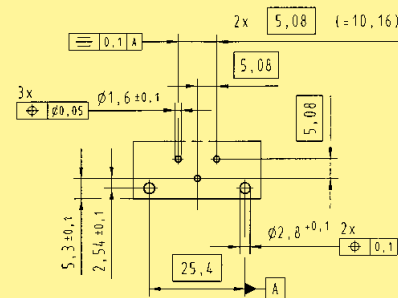

Female connector with solder pins

3

09 06 203 2811

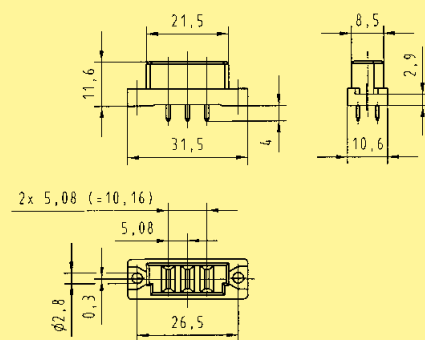

Board drillings

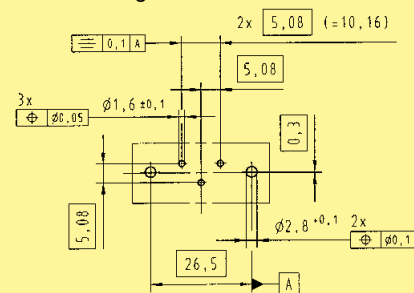

## ELECTRONIC SECTION

Number of contacts	21, 24 + 7
Contact spacing (mm)	
Male connector	2.54 x 5.08
Female connector	5.08
Working current	6 A max.
see current carrying capacity chart	
Clearance	≥ 1.6 mm
Creepage	≥ 3 mm
Working voltage	
The working voltage also depends on the clearance and creepage dimensions on the pcb itself, and the associated wiring	according to the safety regulations of the equipment. Explanations see chapter 00
Test voltage $U_{r.m.s.}$	1.55 kV
Contact resistance	≤ 15 mΩ wrap, solder termination ≤ 20 mΩ including crimp connection
Electrical termination	Solder pins for pcb connection Ø 1 ± 0.1 mm acc. to IEC 60326-3 Wrap posts 1 x 1 mm diagonal 1.34-1.45 mm Crimp terminal 0.09-1.5 mm <sup>2</sup>
Contact surface	
Contact zone	Selectively plated according to performance level <sup>1)</sup>

## HEAVY DUTY SECTION\*

Number of contacts	7
Working current	15 A max.
see current carrying capacity chart	
Clearance	≥ 4.5 mm
Creepage	≥ 8.0 mm
Working voltage	
The working voltage also depends on the clearance and creepage dimensions on the pcb itself, and the associated wiring	according to the safety regulations of the equipment. Explanations see chapter 00
Test voltage $U_{r.m.s.}$	3.1 kV
Contact resistance	≤ 8 mΩ
Electrical termination	Connector for faston 6.3 x 2.5 (faston width x wire gauge) acc. to DIN 46245 and DIN 46247 Solder pins for pcb connection Ø 1.6 ± 0.1 mm acc. to DIN EN 60097
Contact surface	
Contact zone	Hard silver plated

## BOTH PARTS

Insulation resistance	≥ 10 <sup>12</sup> Ω for standard articles ≥ 10 <sup>11</sup> Ω for special NFF articles (with part-no. ending 222)
Temperature range	- 55 °C ... + 125 °C
The higher temperature limit includes the local ambient and heating effects of the contacts under load	

Insertion and withdrawal force ≤ 85 N

## Materials

Mouldings	Thermoplastic resin, glass-fibre filled, UL 94-V0
Contacts	Copper alloy

## Current carrying capacity

The current carrying capacity is limited by maximum temperature of materials for inserts and contacts including terminals. The current capacity curve is valid for continuous, non interrupted current loaded contacts of connectors when simultaneous power on all contacts is given, without exceeding the maximum temperature.

Control and test procedures according to DIN IEC 60512

### Electronic section

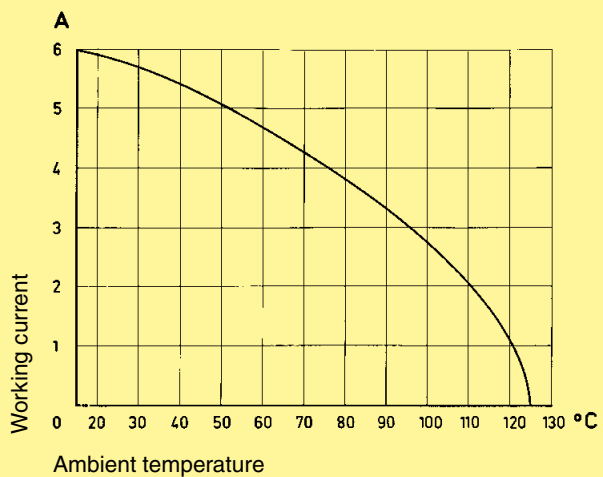

### Heavy duty section

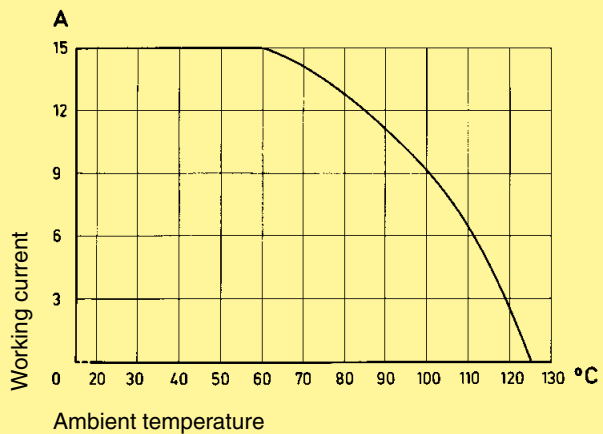

\* only for type MH 24 + 7

<sup>1)</sup> Explanation of performance levels see chapter 00

Mating conditions see chapter 00  
Coding systems see chapter 00

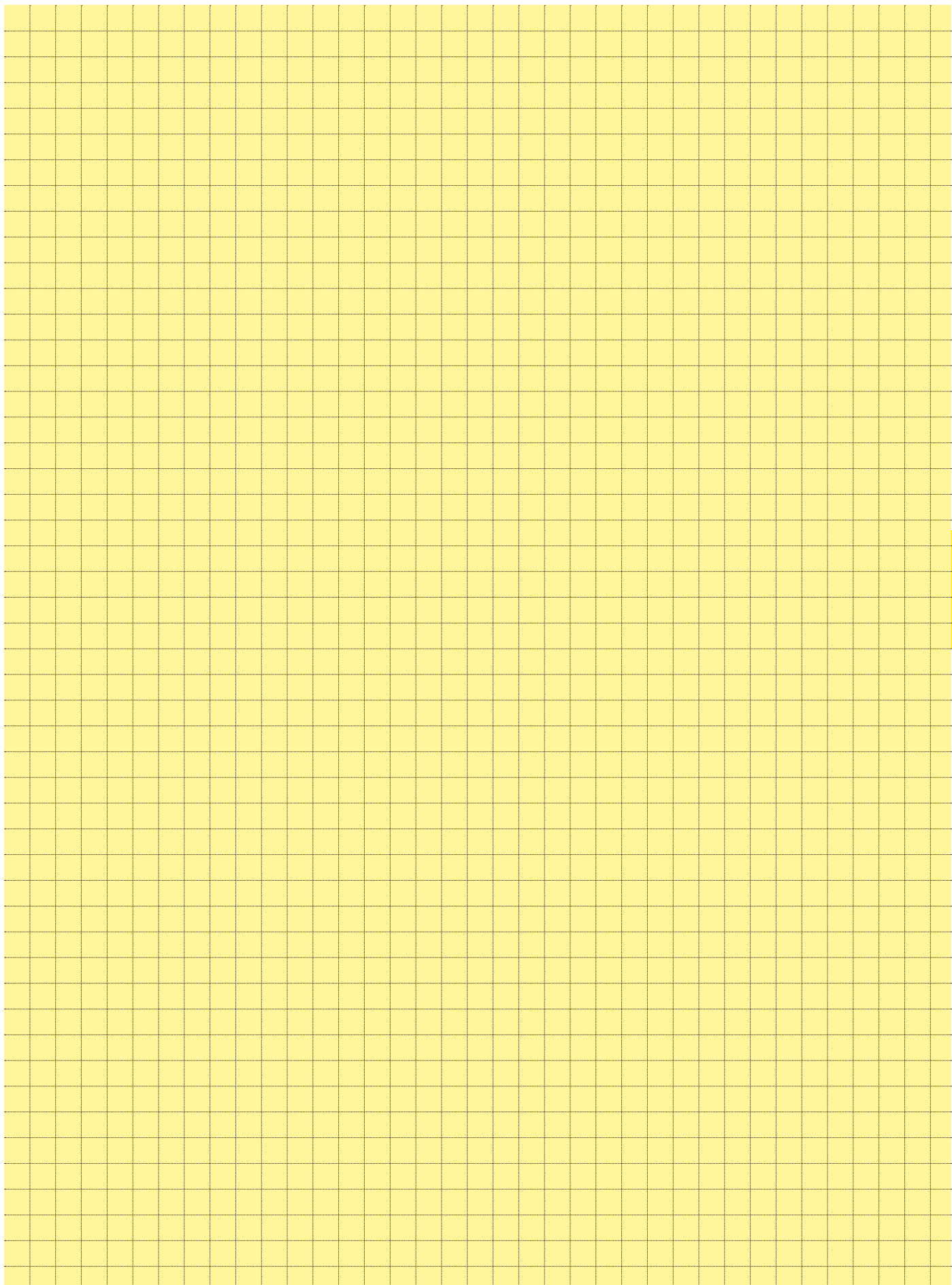

**DIN Power  
up to 15 A**

Number of contacts

**24 + 7**  
F + H

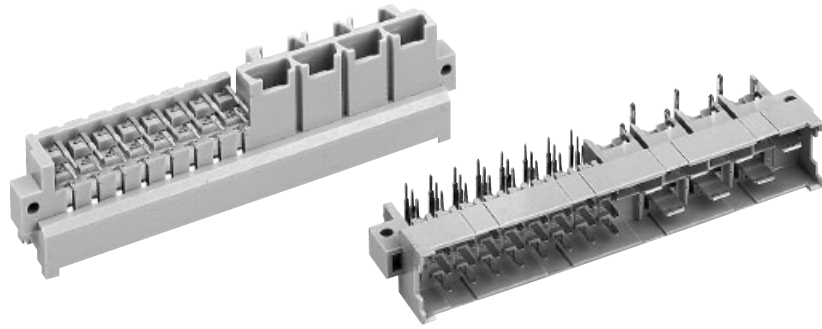

Male connectors

Identification	Number of contacts	Part No. Performance levels according to IEC 60 603-2. Explanation chapter 00		
		3	2	1
Male connector for faston 6.3 x 2.5  1 leading contact (position z 32)  2 leading contacts (position z 2 + z 32)	24 + 7		09 06 031 6921 <sup>1)</sup>	09 06 031 2921 <sup>1)</sup>
	24 + 7		09 06 031 6923 <sup>1)</sup>	
Male connector with angled solder pins <sup>1)</sup>  1 leading contact (position z 32)  2 leading contacts (position z 2 + z 32)	24 + 7		09 06 131 6922	
	24 + 7		09 06 131 6924 09 06 331 6924 <sup>b)</sup>	

DIN Power up to 15 A

Faston terminal

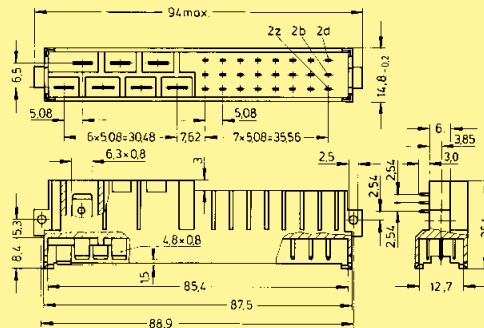

Angled solder pins

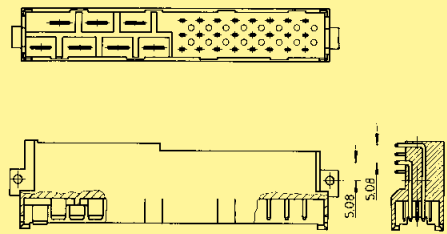

## Board drillings

Mounting side

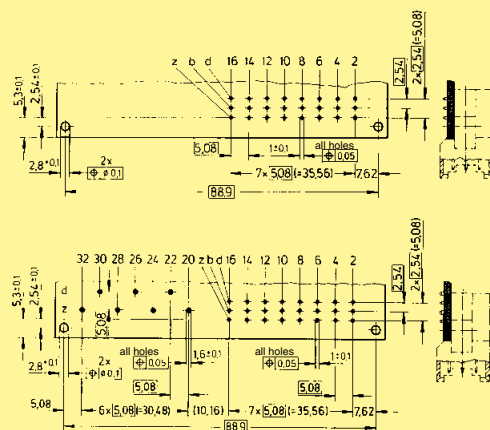

## Contact arrangement

View from termination side

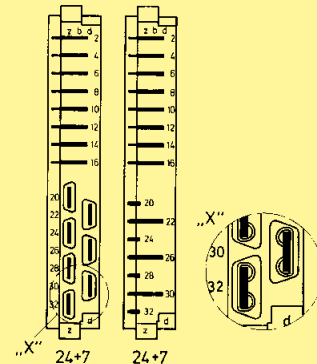

Dimensions in mm

<sup>1)</sup> With shroud coding, see chapter 00  
<sup>b)</sup> Connector with fixing clip see chapter 00  
<sup>1)</sup> Railway classification NFF 16-101, Smoke index: F1, Flammability class: I2

Number of contacts

# 24 + 7

F + H

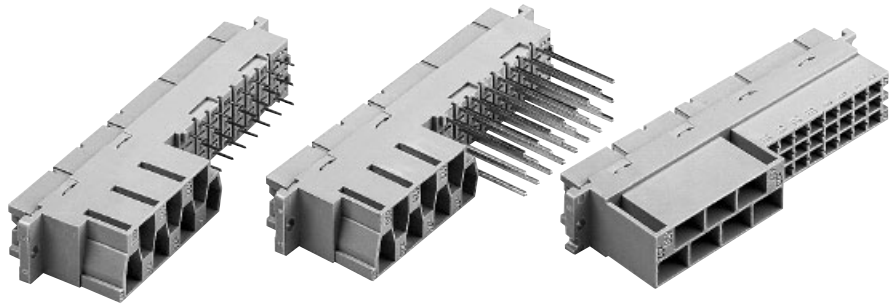

Female connectors

Identification	Number of contacts	Part No.		
		3	2	1
Female connector with solder pins 4.5 mm <sup>1)</sup>	24 + 7		09 06 231 6822 09 06 231 6822 222 <sup>1)</sup>	09 06 231 2822
Female connector with wrap posts 1 x 1 mm <sup>1)</sup>	24 + 7		09 06 231 6821	09 06 231 2821 09 06 231 2821 222 <sup>1)</sup>
Female connector for crimp contacts <sup>1)</sup> Order contacts separately, see chapter 03	24 + 7			09 06 231 2881 09 06 231 2881 222 <sup>1)</sup>

DIN Power up to 15 A

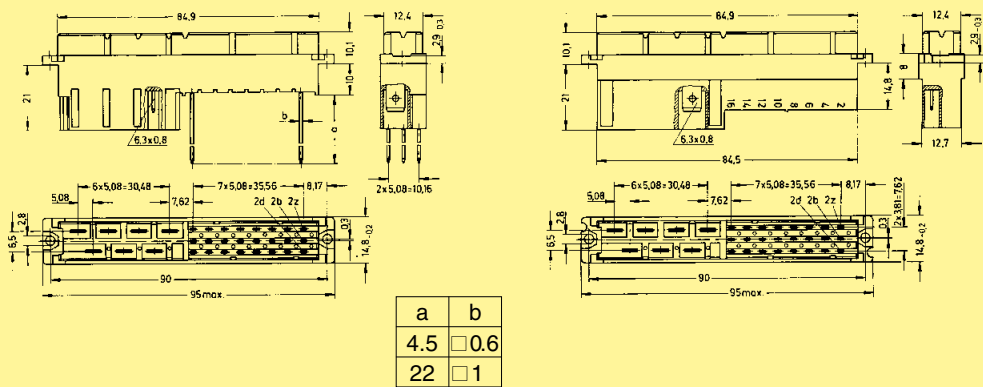

Panel cut out

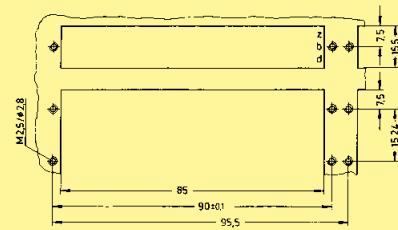

Contact arrangement  
View from termination side

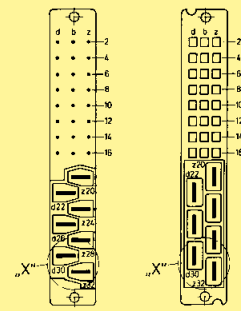

Board drillings  
Mounting side

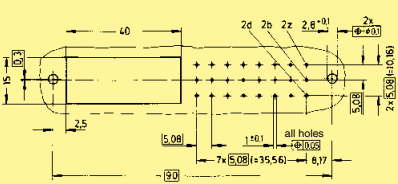

Shell housing for female connector with crimp contacts see chapter 20

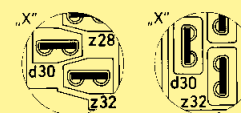

Dimensions in mm

<sup>1)</sup> With shroud coding, see chapter 00

<sup>1)</sup> Railway classification NFF 16-101, Smoke index: F1, Flammability class: I2

Number of contacts

**21 + 5**  
F + M

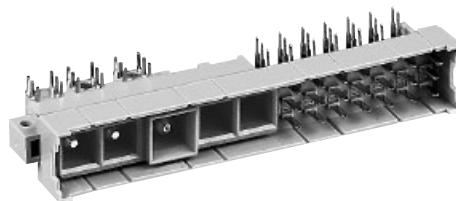

## Male connectors

Identification	Number of contacts	Part No. Performance levels according to IEC 60603-2. Explanation chapter 00		
		3	2	1
Male connector with angled solder pins (without special contacts)*	21 + 5	Performance level 3 on request	09 06 121 6981	Performance level 1 on request
High current contact for printed circuit terminations max. 40 A <sup>2)</sup>			09 03 000 6127	
leading contact max. 40 A <sup>2)</sup>			09 03 000 6128	
Removal tool			09 99 000 0328	

## Dimensions

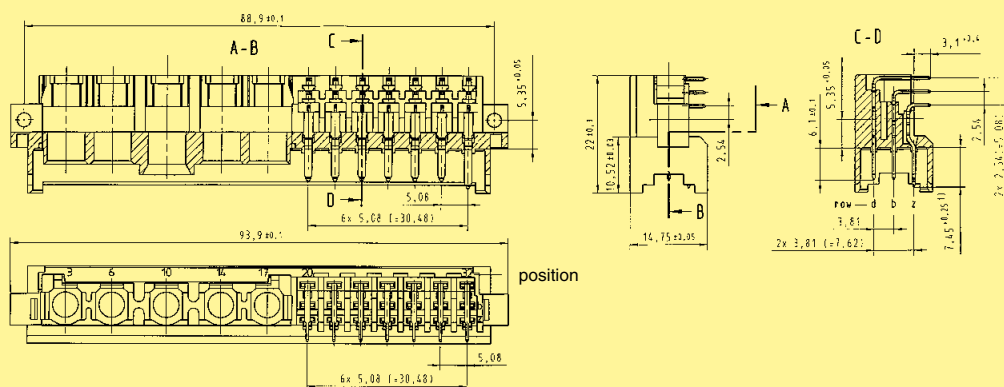

## Board drillings Mounting side

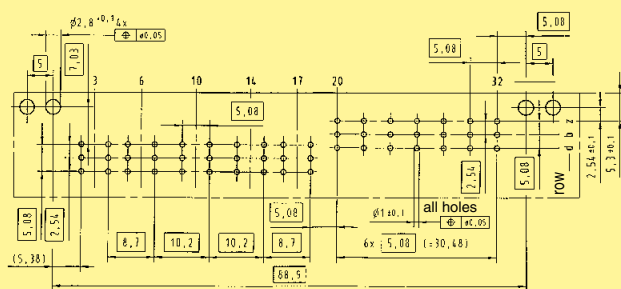

1) Leading contact in position z 32

## Dimensions

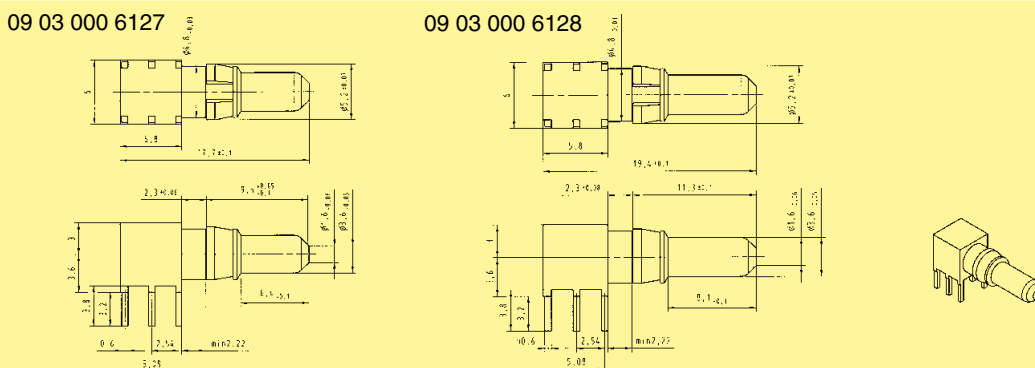

Dimensions in mm

\* Pre-loaded with special contacts on request

Code keys see chapter 00

2) Depending on the pcb design

Further special contacts see chapter 01

# DIN 41 612 · complementary type MH



Number of contacts

**21 + 5**  
F + M

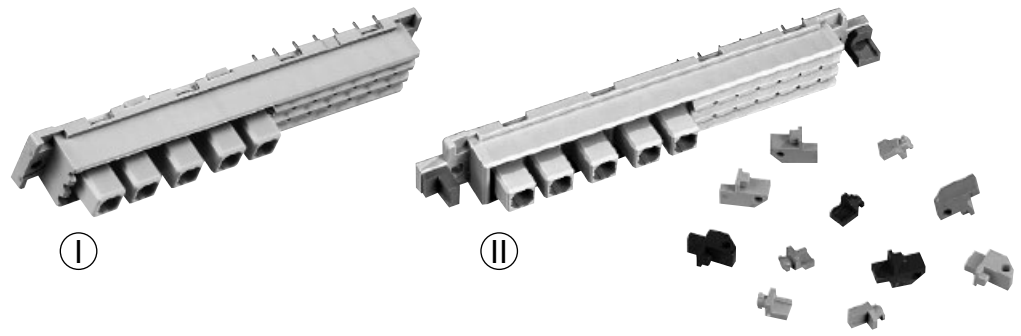

Female connectors

Identification	Number of contacts	Part No. 3	Performance levels according to IEC 60603-2. Explanation chapter 00 2	1
Female connector with solder pins 3.2 mm (without special contacts)	without flange coding (I)	Performance level 3 on request	09 06 221 6883	Performance level 1 on request
	with flange coding <sup>1)</sup> (II)		09 06 721 6883	
High current contact Crimp contacts for printed circuit termination 20 A			09 03 000 6220	

## Dimensions

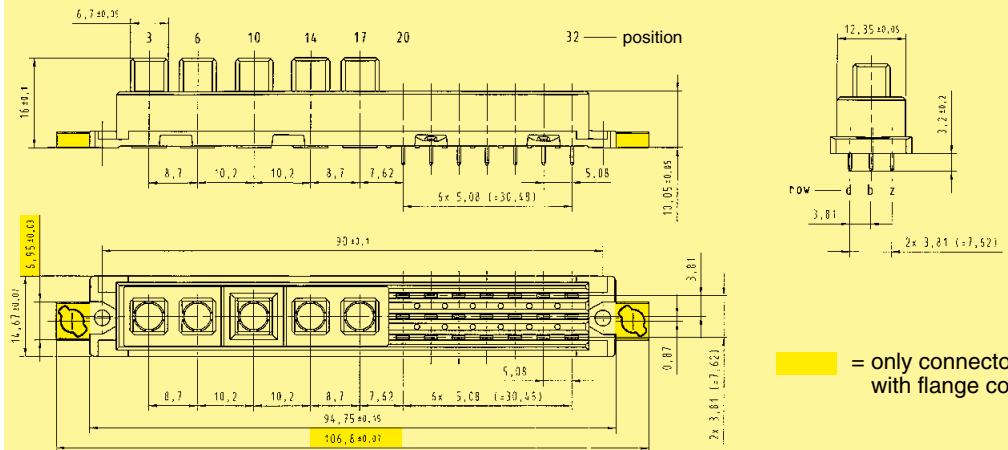

## Board drillings Mounting side

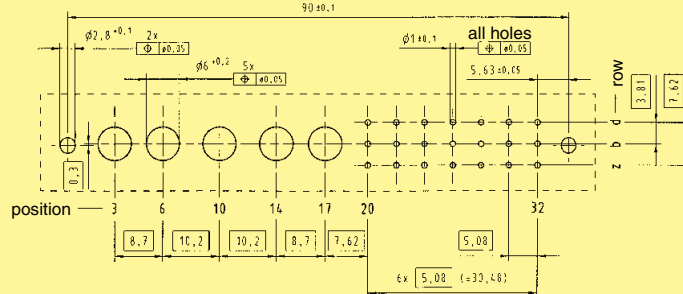

## Dimensions

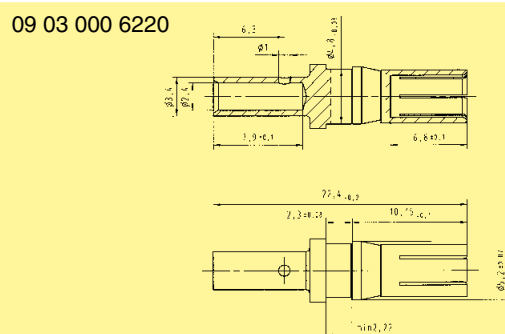

Dimensions in mm

DIN Power  
up to 15 A

= only connectors with flange coding

<sup>1)</sup> Code keys see chapter 00  
Removal tool for contacts is available with part number 09 99 000 0174

Further special contacts see chapter 01

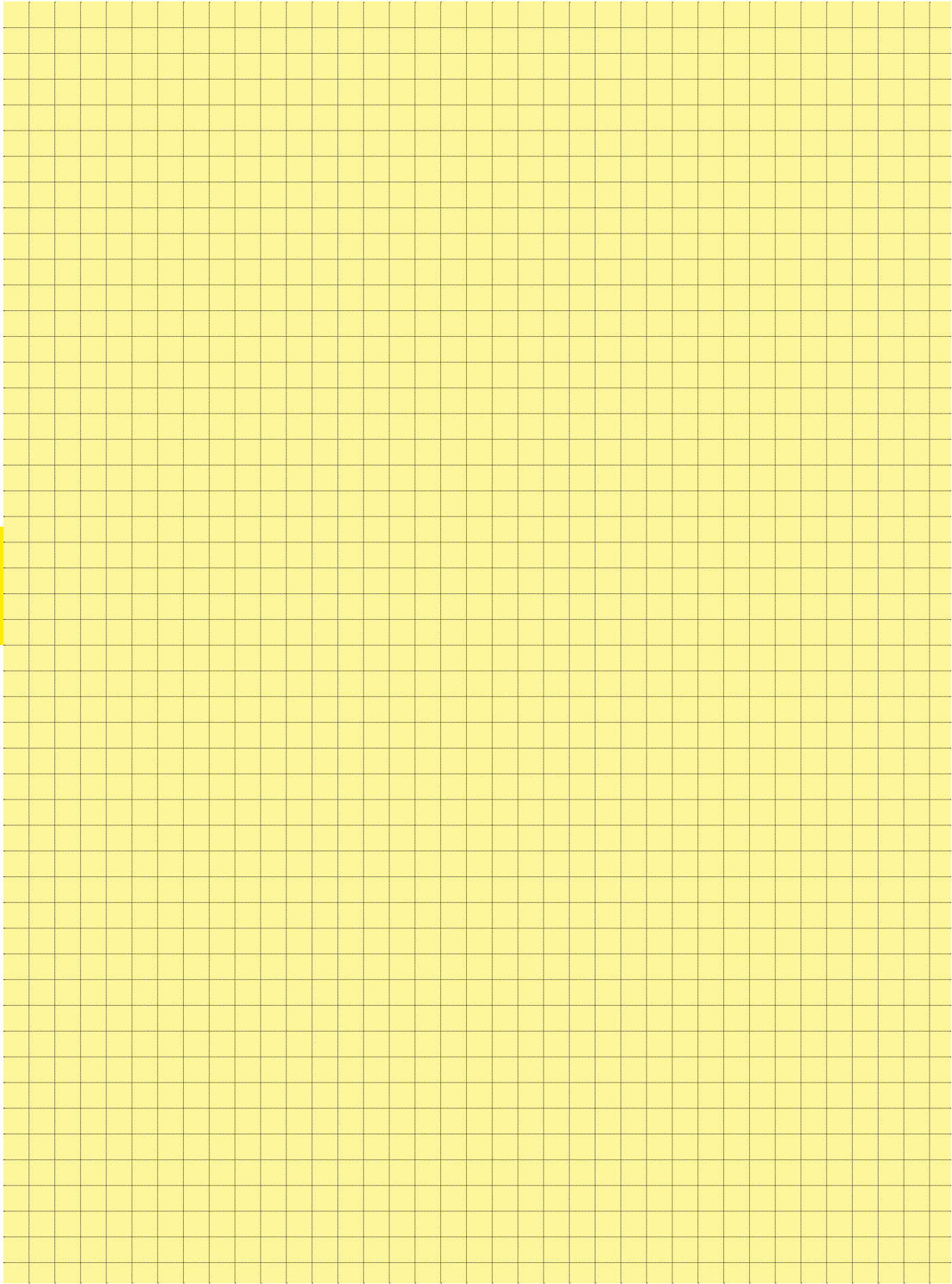

**DIN Power  
up to 15 A**