

**SEK – Insulation Displacement Connector system (IDC), 2.54 mm pitch**

Page

General information ..... **09.02**

**Solder board connectors**

Technical characteristics ..... **09.04**

Male standard connectors ..... **09.06**

Male standard connectors, kinked ..... **09.10**

Male standard connectors with board lock ..... **09.12**

Male low-profile connectors ..... **09.14**

Accessories ..... **09.16**

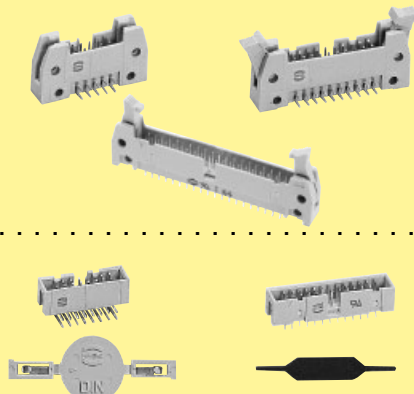

**Wrap post connectors**

Technical characteristics ..... **09.17**

Male standard connectors ..... **09.18**

Accessories ..... **09.20**



**Cable connectors**

Technical characteristics for female connectors ..... **09.21**

Female connectors ..... **09.22**

Technical characteristics for pcb transition connectors, 2 rows ..... **09.24**

Pcb transition connectors, 2 rows ..... **09.25**

Technical characteristics for pcb transition connectors, 4 rows ..... **09.26**

Pcb transition connectors, 4 rows ..... **09.27**

Technical characteristics for DIP connectors ..... **09.28**

DIP connectors ..... **09.29**

Technical characteristics for DIN 41 612 connectors ..... **09.30**



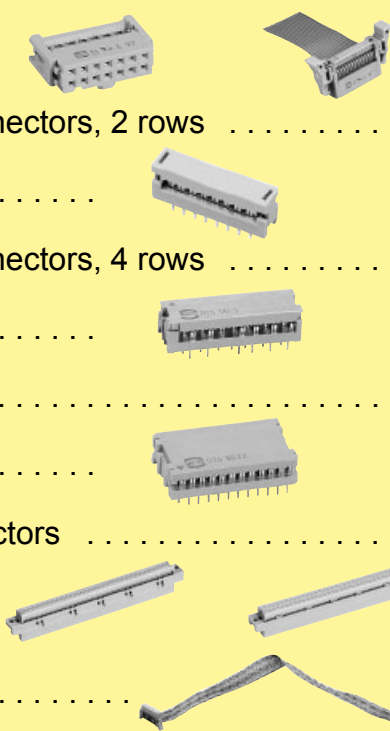

DIN 41 612 connectors ..... **09.31**



**Cables and cable assemblies**

see chapter 40

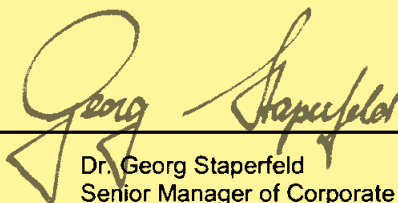
## Declaration of conformity

<p><i>This Declaration of Conformity is suitable to the European Standard EN 45 014, „General criteria for suppliers declaration of conformity“.</i></p> <p><i>The basis for the criteria has been found in international documentation, particularly in ISO/IEC Guide 22, 1996, „Information on manufacturers declaration of conformity with standards or other technical specifications“.</i></p>	<p>We</p> <p><b>HARTING KGaA</b></p> <p><b>Marienwerder Str. 3</b> <b>32339 Espelkamp</b></p> <p><b>HARTING Electronics GmbH &amp; Co KG</b> <b>Marienwerder Str.3</b> <b>32339 Espelkamp</b></p> <p>declare under our own responsibility that the</p> <p style="text-align: center;"><b>Flat Cable Connector System</b></p> <p>is in conformity with the following standard <b>IEC 60603-13</b> <b>Connectors for frequencies below 3MHz</b> <b>for use with printed board-Part 13:</b> <b>Detail specification for two-part connectors with assessed quality, for printed boards, for basic grid of 2,54 mm (0,1in) with free connectors for non – accessible insulation displacement termination (ID)</b></p> <p>This declaration of conformity refers to the series:</p> <p style="text-align: center;"><b>SEK</b></p>
	<p>Our testing laboratory is accredited and monitored by the German Accreditation Body Technology/ (DATEch). Reg.-Nr. DAT-P-041/94-02</p>
<p>QUALITY SYSTEM</p> 	<p>Our quality system is certified and monitored by DQS in conformity with the standard DIN EN ISO 9001 : 2000. Cert.-Nr. 002204 QM</p>
<p><u>Espekamp, 2004-11-18</u> Place and Date of publication</p>	 <p>Dr. Georg Staperfeld Senior Manager of Corporate Technology Services</p>
<p><u>Espekamp, 2004-11-18</u> Place and Date of publication</p>	 <p>Dipl.-Ing. Hartmuth Schmidt Director Global Product Management HARTING Electronics GmbH &amp; Co KG</p>

The HARTING Insulation Displacement Connector system

Economic and reliable connections

The flat cable and connector can be preassembled and used as a component with predetermined functional characteristics.

The HARTING insulation displacement contacts pierce the insulation on the flat cable to provide a durable gastight connection with the wire.

The HARTING insulation displacement technique constitutes the ideal solution to your wiring problems.

For "non standard applications" we can manufacture designs to match your requirements. Please discuss requirements with us.

HARTING SEK connectors incorporate the latest design features and provide the assurance of high quality and reliability with economy.

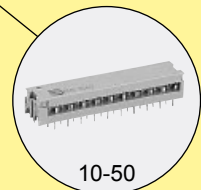
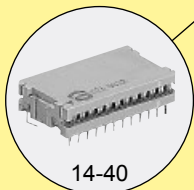
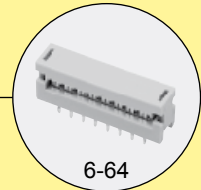
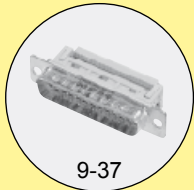
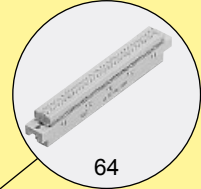
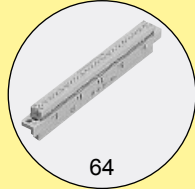
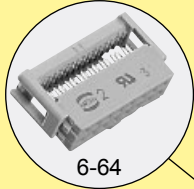

**Cable assemblies**

- HARTING can supply cable assemblies to customer specifications.
- A wide range of connector types available with various contact arrangements constitute the ideal solution to your wiring problems.
- Cables of all types in economic reel lengths are available.

**Quality**

- Cables professionally assembled on HARTING work stations ensure reliable connections.
- Finished harnesses are subject to 100% quality checks on a HARTING test device.
- Insulation test.
- Contact resistance test.

**Economy**

- The tested assembly of connectors and flat cables from one manufacturer guarantees a high degree of economy and reliability.
- Investment for work stations and test devices are not required.
- Stocks of piece parts are reduced.

SEK

Number of contacts 6, 10, 14, 16, 20, 24, 26, 30, 34, 40, 50, 60, 64

Contact arrangement straight, angled

Contact length 2.9 mm, 4.5 mm

Approvals IEC 60603-13  
DIN EN 60603-13  
D 2632  
BT 224  
NFC 93-428 (HE 10)  
UL recognized: E102079



Pitch 2.54 mm [0.100"]

Working current 1 A

Working voltage 500 V for pollution degree 1

Test voltage  $U_{r.m.s.}$  1 kV

Contact resistance  $\leq 20 \text{ m}\Omega$   
Insulation resistance  $\geq 10^9 \Omega$

Temperature range -55 °C ... + 125 °C  
The maximum temperature includes heating of contacts and ambient temperature

Terminations For pcb hole  $\varnothing 1 \pm 0.1 \text{ mm}$   
DIN IEC 52 141  
Diagonal: 0.79 mm

Materials Moulding Thermoplastic resin (PBT)  
UL 94-V0

Contact surface Contact zone plated according to performance level<sup>1)</sup>

### Current carrying capacity

The current carrying capacity is limited by maximum temperature of materials for inserts and contacts including terminals. The current capacity-curve is valid for continuous, not interrupted current-loaded contacts of connectors when simultaneous power on all contacts is given, without exceeding the maximum temperature.

Control and test procedures according to DIN IEC 60 512.

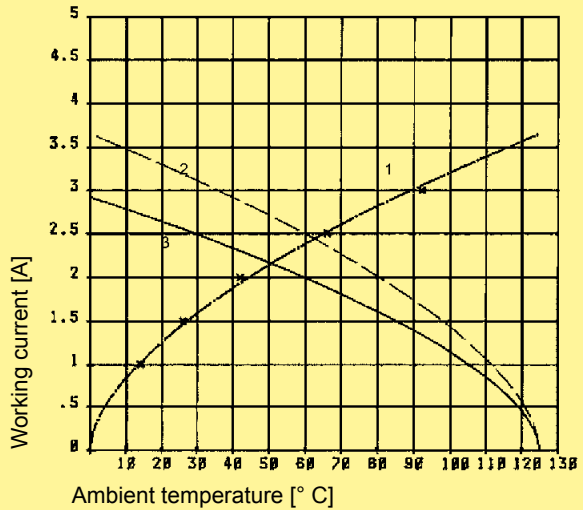

Example: 50 way connector

- ① Temperature rise
- ② Derating
- ③ Derating curve at  $I_{max} \times 0.8$  (IEC 60 512-2)

### Insertion and withdrawal forces

Number of contacts	Maximum force [N]	
	Performance level 1 and 2	Performance level 3
6	12	18
10	20	30
14	28	42
16	32	48
20	40	60
24	48	72
26	52	78
30	60	90
34	68	102
40	80	120
50	100	150
60	120	180
64	128	192

SEK

<sup>1)</sup> Performance level 3 as per IEC 60 603-13,  $\geq 50$  mating cycles, no gas test  
Performance level 2 as per IEC 60 603-13,  $\geq 250$  mating cycles, 4 days gas test  
S4, plating = 0.76  $\mu\text{m}$  (30  $\mu\text{inch}$ ) Au or PdNi equivalent

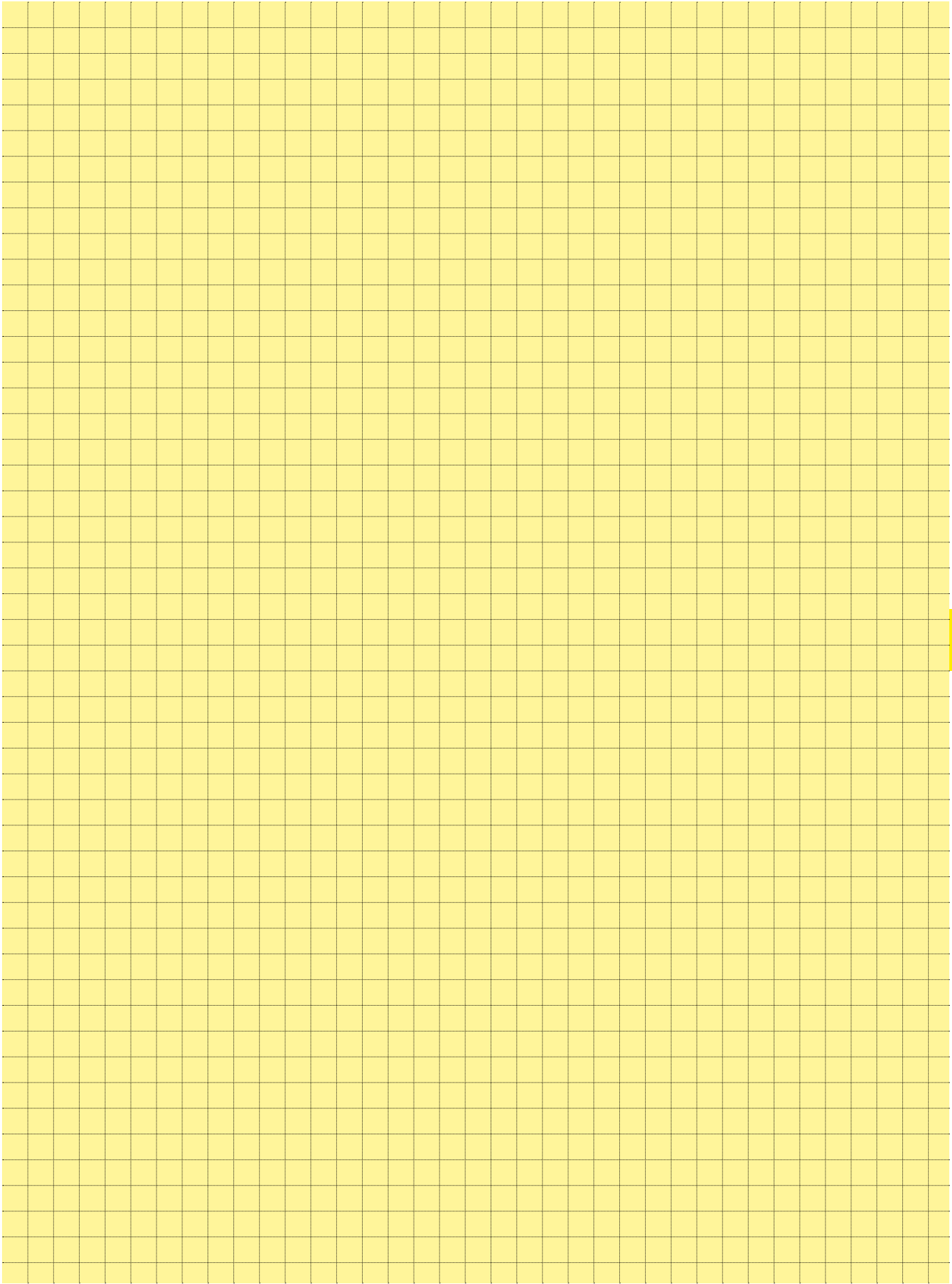

Number of contacts

6-64

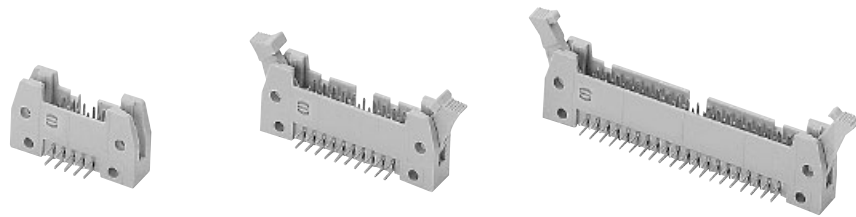

Male header with angled solder pins

Identification	No. of contacts	Part No.					
		Without levers		With short levers		With long levers	
<b>Male header with angled solder pins</b> Length: 2.9 mm							
	6	09 18 506	└ 923	09 18 506	└ 913	09 18 506	└ 903
	10	09 18 510	└ 923	09 18 510	└ 913	09 18 510	└ 903
	14	09 18 514	└ 923	09 18 514	└ 913	09 18 514	└ 903
	16	09 18 516	└ 923	09 18 516	└ 913	09 18 516	└ 903
	20	09 18 520	└ 923	09 18 520	└ 913	09 18 520	└ 903
	24	09 18 524	└ 923	09 18 524	└ 913	09 18 524	└ 903
	26	09 18 526	└ 923	09 18 526	└ 913	09 18 526	└ 903
	30	09 18 530	└ 923	09 18 530	└ 913	09 18 530	└ 903
	34	09 18 534	└ 923	09 18 534	└ 913	09 18 534	└ 903
	40	09 18 540	└ 923	09 18 540	└ 913	09 18 540	└ 903
	50	09 18 550	└ 923	09 18 550	└ 913	09 18 550	└ 903
	60	09 18 560	└ 923	09 18 560	└ 913	09 18 560	└ 903
	64	09 18 564	└ 923	09 18 564	└ 913	09 18 564	└ 903
Kinked version on request							
<b>Male header with angled solder pins</b> Length: 4.5 mm							
	6	09 18 506	└ 921*	09 18 506	└ 911*	09 18 506	└ 901*
	10	09 18 510	└ 921*	09 18 510	└ 911*	09 18 510	└ 901*
	14	09 18 514	└ 921*	09 18 514	└ 911*	09 18 514	└ 901*
	16	09 18 516	└ 921*	09 18 516	└ 911*	09 18 516	└ 901*
	20	09 18 520	└ 921*	09 18 520	└ 911*	09 18 520	└ 901*
	24	09 18 524	└ 921*	09 18 524	└ 911*	09 18 524	└ 901*
	26	09 18 526	└ 921*	09 18 526	└ 911*	09 18 526	└ 901*
	30	09 18 530	└ 921*	09 18 530	└ 911*	09 18 530	└ 901*
	34	09 18 534	└ 921*	09 18 534	└ 911*	09 18 534	└ 901*
	40	09 18 540	└ 921*	09 18 540	└ 911*	09 18 540	└ 901*
	50	09 18 550	└ 921*	09 18 550	└ 911*	09 18 550	└ 901*
	60	09 18 560	└ 921*	09 18 560	└ 911*	09 18 560	└ 901*
	64	09 18 564	└ 921*	09 18 564	└ 911*	09 18 564	└ 901*
Kinked version on request							

SEK

09-06

\* Not normally kept in stock  
 For accessories see page 09.16  
 For dimensions see page 09.07

For performance level 3 please specify digit  $\begin{matrix} \boxed{7} \\ \boxed{6} \\ \boxed{5} \end{matrix}$  \*  
 For performance level 2 please specify digit  $\begin{matrix} \boxed{7} \\ \boxed{6} \\ \boxed{5} \end{matrix}$  \*

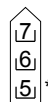
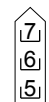

Number of contacts

# 6-64

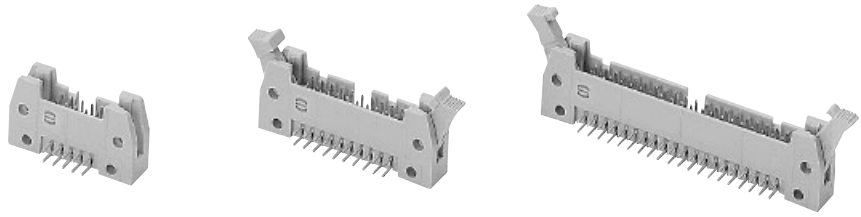

Male header with angled solder pins

Identification

Drawing

Dimensions in mm

Male header

No. of contacts	A	B	D	E	F	G
6	26.9	16.76	12.45	2.54 x 2 = 5.08	36.9	40.3
10	32.0	21.84	17.53	2.54 x 4 = 10.16	42.0	45.4
14	37.1	26.92	22.61	2.54 x 6 = 15.24	47.1	50.4
16	39.6	29.46	25.15	2.54 x 7 = 17.78	49.6	53.0
20	44.7	34.54	30.23	2.54 x 9 = 22.86	54.7	58.1
24	49.8	39.62	35.91	2.54 x 11 = 27.94	59.8	63.2
26	52.3	42.16	37.85	2.54 x 12 = 30.48	62.3	65.7
30	57.7	47.24	43.83	2.54 x 14 = 35.56	68.2	68.6
34	62.5	52.32	48.01	2.54 x 16 = 40.64	72.5	75.8
40	70.1	59.94	55.63	2.54 x 19 = 48.26	80.1	83.5
50	82.8	72.64	68.33	2.54 x 24 = 60.96	92.8	96.2
60	95.5	85.34	81.03	2.54 x 29 = 73.66	105.5	108.9
64	100.6	90.42	86.11	2.54 x 31 = 78.74	110.6	113.9

**Short levers**

for use with female connector without strain relief clamp

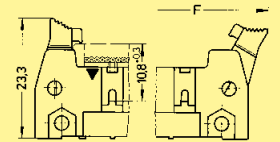
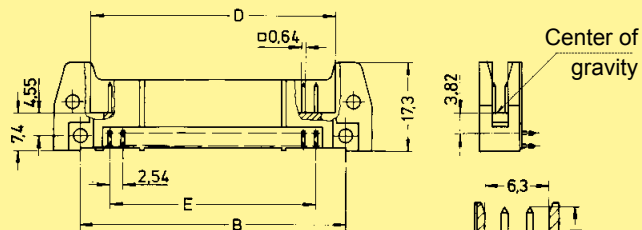

**Long levers**

for use with female connector with strain relief clamp

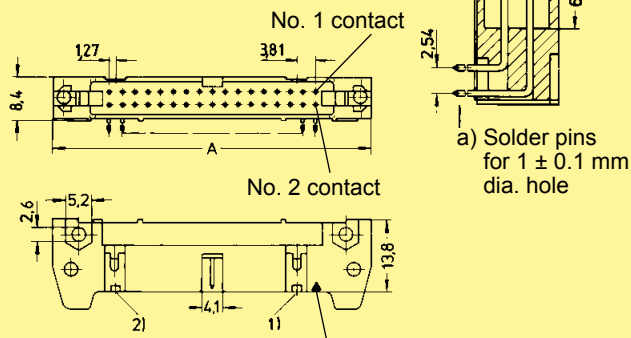

a) Solder pins for 1 ± 0.1 mm dia. hole

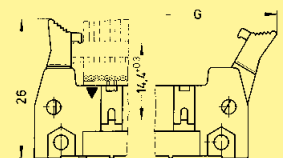

Board drillings

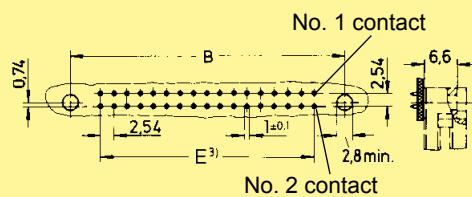

For accessories see page 09.16

1) No polarization slot for 6, 10 or 14 way male header

2) No polarization slot for 6 way male header

3) Pitch tolerance: ± 0.1

Number of contacts

6-64

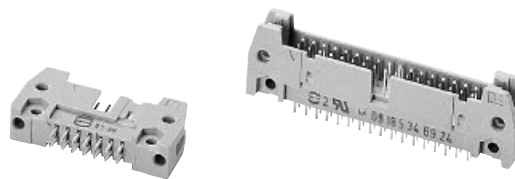

Male header with straight solder pins

Identification	No. of contacts	Part No.					
		Without levers		With short levers		With long levers	
Male header with straight solder pins Length: 2.9 mm	6	09 18 506	└ 924	09 18 506	└ 914	09 18 506	└ 904
	10	09 18 510	└ 924	09 18 510	└ 914	09 18 510	└ 904
	14	09 18 514	└ 924	09 18 514	└ 914	09 18 514	└ 904
	16	09 18 516	└ 924	09 18 516	└ 914	09 18 516	└ 904
	20	09 18 520	└ 924	09 18 520	└ 914	09 18 520	└ 904
	24	09 18 524	└ 924	09 18 524	└ 914	09 18 524	└ 904
	26	09 18 526	└ 924	09 18 526	└ 914	09 18 526	└ 904
	30	09 18 530	└ 924	09 18 530	└ 914	09 18 530	└ 904
	34	09 18 534	└ 924	09 18 534	└ 914	09 18 534	└ 904
	40	09 18 540	└ 924	09 18 540	└ 914	09 18 540	└ 904
	50	09 18 550	└ 924	09 18 550	└ 914	09 18 550	└ 904
	60	09 18 560	└ 924	09 18 560	└ 914	09 18 560	└ 904
	64	09 18 564	└ 924	09 18 564	└ 914	09 18 564	└ 904
	Male header with straight solder pins Length: 4.5 mm	6	09 18 506	└ 922*	09 18 506	└ 912*	09 18 506
10		09 18 510	└ 922*	09 18 510	└ 912*	09 18 510	└ 902*
14		09 18 514	└ 922*	09 18 514	└ 912*	09 18 514	└ 902*
16		09 18 516	└ 922*	09 18 516	└ 912*	09 18 516	└ 902*
20		09 18 520	└ 922*	09 18 520	└ 912*	09 18 520	└ 902*
24		09 18 524	└ 922*	09 18 524	└ 912*	09 18 524	└ 902*
26		09 18 526	└ 922*	09 18 526	└ 912*	09 18 526	└ 902*
30		09 18 530	└ 922*	09 18 530	└ 912*	09 18 530	└ 902*
34		09 18 534	└ 922*	09 18 534	└ 912*	09 18 534	└ 902*
40		09 18 540	└ 922*	09 18 540	└ 912*	09 18 540	└ 902*
50		09 18 550	└ 922*	09 18 550	└ 912*	09 18 550	└ 902*
60		09 18 560	└ 922*	09 18 560	└ 912*	09 18 560	└ 902*
64		09 18 564	└ 922*	09 18 564	└ 912*	09 18 564	└ 902*

Kinked version on request

\* Not normally kept in stock  
For accessories see page 09.16  
For dimensions see page 09.09

For performance level 3 please specify digit 7\*  
For performance level 2 please specify digit 6\*  
S4 = 0.76 µm (30 µinch) Au or PdNi equivalent

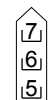
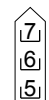
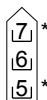



Number of contacts

# 6-64

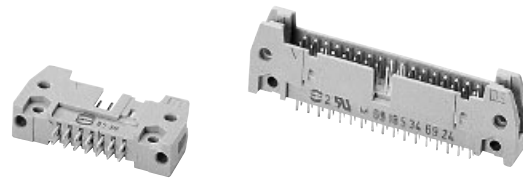

Male header with straight solder pins

Identification

Drawing

Dimensions in mm

Male header

No. of contacts	A	C	D	E	F	G
6	26.9	22.86	12.45	2.54 x 2 = 5.08	36.9	40.3
10	32.0	27.94	17.53	2.54 x 4 = 10.16	42.0	45.4
14	37.1	33.02	22.61	2.54 x 6 = 15.24	47.1	50.4
16	39.6	35.56	25.15	2.54 x 7 = 17.78	49.6	53.0
20	44.7	40.64	30.23	2.54 x 9 = 22.86	54.7	58.1
24	49.8	45.72	35.91	2.54 x 11 = 27.94	59.8	63.2
26	52.3	48.26	37.85	2.54 x 12 = 30.48	62.3	65.7
30	57.7	53.34	43.83	2.54 x 14 = 35.56	68.2	68.6
34	62.5	58.42	48.01	2.54 x 16 = 40.64	72.5	75.8
40	70.1	66.04	55.63	2.54 x 19 = 48.26	80.1	83.5
50	82.8	78.74	68.33	2.54 x 24 = 60.96	92.8	96.2
60	95.5	91.44	81.03	2.54 x 29 = 73.66	105.5	108.9
64	100.6	96.52	86.11	2.54 x 31 = 78.74	110.6	113.9

**Short levers**

for use with female connector without strain relief clamp

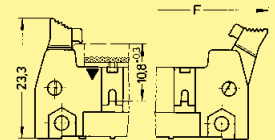
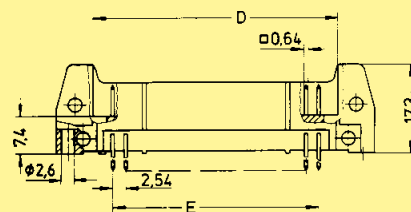

**Long levers**

for use with female connector with strain relief clamp

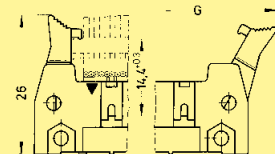
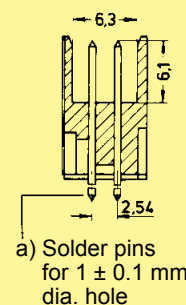
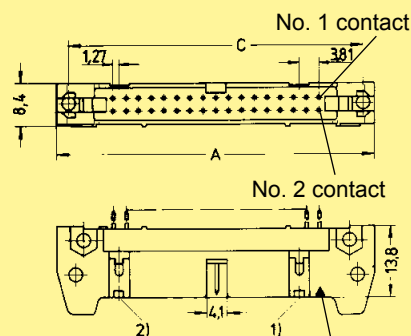

Marking No. 1 contact

Board drillings

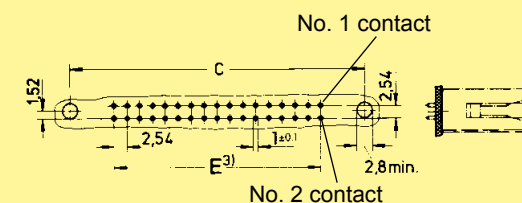

1) No polarization slot for 6, 10 or 14 way male header

2) No polarization slot for 6 way male header  
3) Pitch tolerance: ± 0.1

Number of contacts

**6-64**

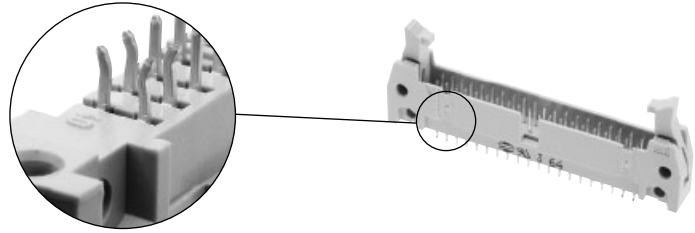

Male header with straight solder pins, kinked

Identification	No. of contacts	Part No.					
		Without levers		With short levers		With long levers	
Male header with straight solder pins, kinked Length: 2.9 mm	6	09 18 506	└ 024	09 18 506	└ 014	09 18 506	└ 004
	10	09 18 510	└ 024	09 18 510	└ 014	09 18 510	└ 004
	14	09 18 514	└ 024	09 18 514	└ 014	09 18 514	└ 004
	16	09 18 516	└ 024	09 18 516	└ 014	09 18 516	└ 004
	20	09 18 520	└ 024	09 18 520	└ 014	09 18 520	└ 004
	24	09 18 524	└ 024	09 18 524	└ 014	09 18 524	└ 004
	26	09 18 526	└ 024	09 18 526	└ 014	09 18 526	└ 004
	30	09 18 530	└ 024	09 18 530	└ 014	09 18 530	└ 004
	34	09 18 534	└ 024	09 18 534	└ 014	09 18 534	└ 004
	40	09 18 540	└ 024	09 18 540	└ 014	09 18 540	└ 004
	50	09 18 550	└ 024	09 18 550	└ 014	09 18 550	└ 004
	60	09 18 560	└ 024	09 18 560	└ 014	09 18 560	└ 004
	64	09 18 564	└ 024	09 18 564	└ 014	09 18 564	└ 004

SEK

09  
-  
10

\* Not normally kept in stock  
 For accessories see page 09.16  
 For dimensions see page 09.11

For performance level 3 please specify digit 7\*  
 For performance level 2 please specify digit 6\*  
 S4 = 0.76 µm (30 µinch) Au or PdNi equivalent

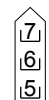

Number of contacts

# 6-64

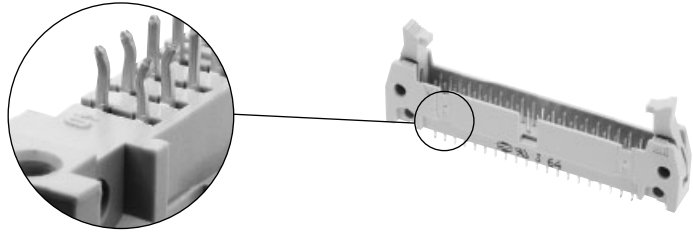

Male header with straight solder pins, kinked

Identification

Drawing

Dimensions in mm

Male header

No. of contacts	A	C	D	E	F	G
6	26.9	22.86	12.45	2.54 x 2 = 5.08	36.9	40.3
10	32.0	27.94	17.53	2.54 x 4 = 10.16	42.0	45.4
14	37.1	33.02	22.61	2.54 x 6 = 15.24	47.1	50.4
16	39.6	35.56	25.15	2.54 x 7 = 17.78	49.6	53.0
20	44.7	40.64	30.23	2.54 x 9 = 22.86	54.7	58.1
24	49.8	45.72	35.91	2.54 x 11 = 27.94	59.8	63.2
26	52.3	48.26	37.85	2.54 x 12 = 30.48	62.3	65.7
30	57.7	53.34	43.83	2.54 x 14 = 35.56	68.2	68.6
34	62.5	58.42	48.01	2.54 x 16 = 40.64	72.5	75.8
40	70.1	66.04	55.63	2.54 x 19 = 48.26	80.1	83.5
50	82.8	78.74	68.33	2.54 x 24 = 60.96	92.8	96.2
60	95.5	91.44	81.03	2.54 x 29 = 73.66	105.5	108.9
64	100.6	96.52	86.11	2.54 x 31 = 78.74	110.6	113.9

Short levers

for use with female connector without strain relief clamp

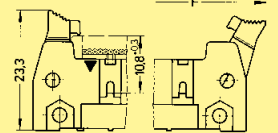
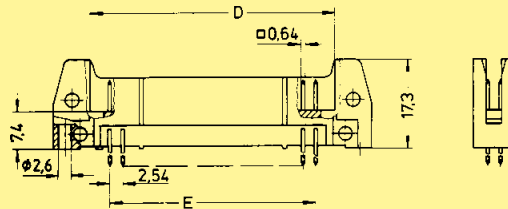

Long levers

for use with female connector with strain relief clamp

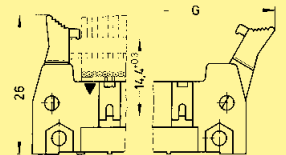
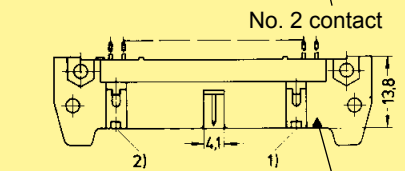
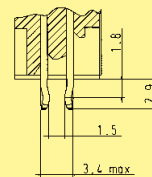
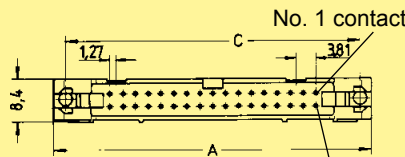

Marking No. 1 contact

No. 1 contact

Board drillings

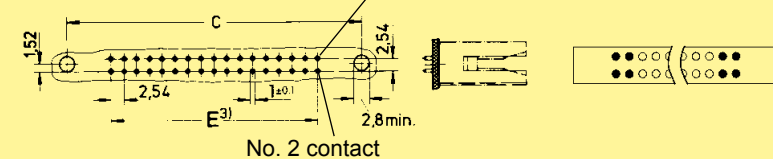

● Kinked contact: pcb thickness from 1.50 to 1.94 mm after Cu + Sn plating with non-remelted through holes  $\varnothing$  0.80 to  $\varnothing$  0.95 mm. Max. insertion force = 125 N. Min. retention force = 3 N.

○ Non-kinked contact: Solder pins for pcb connections  $\varnothing$  1 ± 0.1 mm as per IEC 60603-13.

For accessories see page 09.16

1) No polarization slot for 6, 10 or 14 way male header

2) No polarization slot for 6 way male header

3) Pitch tolerance: ± 0.1

Number of contacts

# 6-64

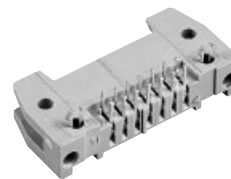

Male header with angled solder pins and board lock

Identification	No. of contacts	Part No.					
		Without levers		With short levers		With long levers	
<p>Male header with angled solder pins and pcb board lock</p> <p>Length: 2.9 mm for 1.6 mm pcb thickness</p> <p>To hold the connector on the pcb before the soldering process, two board locks have been added on the male header with angled solder pins.</p>	6	09 18 506	└ 973*	09 18 506	└ 963*	09 18 506	└ 953*
	10	09 18 510	└ 973*	09 18 510	└ 963*	09 18 510	└ 953*
	14	09 18 514	└ 973*	09 18 514	└ 963*	09 18 514	└ 953*
	16	09 18 516	└ 973*	09 18 516	└ 963*	09 18 516	└ 953*
	20	09 18 520	└ 973*	09 18 520	└ 963*	09 18 520	└ 953*
	24	09 18 524	└ 973*	09 18 524	└ 963*	09 18 524	└ 953*
	26	09 18 526	└ 973*	09 18 526	└ 963*	09 18 526	└ 953*
	30	09 18 530	└ 973*	09 18 530	└ 963*	09 18 530	└ 953*
	34	09 18 534	└ 973*	09 18 534	└ 963*	09 18 534	└ 953*
	40	09 18 540	└ 973*	09 18 540	└ 963*	09 18 540	└ 953*
	50	09 18 550	└ 973*	09 18 550	└ 963*	09 18 550	└ 953*
	60	09 18 560	└ 973*	09 18 560	└ 963*	09 18 560	└ 953*
	64	09 18 564	└ 973*	09 18 564	└ 963*	09 18 564	└ 953*

SEK

09-12

\* Not normally kept in stock

For performance level 3 please specify digit 7  
 For performance level 2 please specify digit 6  
 S4 = 0.76 µm (30 µinch) Au or PdNi equivalent

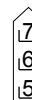
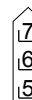
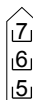

Number of contacts

# 6-64

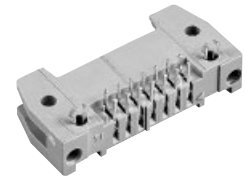

Male header with angled solder pins and board lock

Identification

Drawing

Dimensions in mm

Male header

No. of contacts	A	B	D	E	F	G
6	26.9	16.76	12.45	2.54 x 2 = 5.08	36.9	40.3
10	32.0	21.84	17.53	2.54 x 4 = 10.16	42.0	45.4
14	37.1	26.92	22.61	2.54 x 6 = 15.24	47.1	50.4
16	39.6	29.46	25.15	2.54 x 7 = 17.78	49.6	53.0
20	44.7	34.54	30.23	2.54 x 9 = 22.86	54.7	58.1
24	49.8	39.62	35.91	2.54 x 11 = 27.94	59.8	63.2
26	52.3	42.16	37.85	2.54 x 12 = 30.48	62.3	65.7
30	57.7	47.24	43.83	2.54 x 14 = 35.56	68.2	68.6
34	62.5	52.32	48.01	2.54 x 16 = 40.64	72.5	75.8
40	70.1	59.94	55.63	2.54 x 19 = 48.26	80.1	83.5
50	82.8	72.64	68.33	2.54 x 24 = 60.96	92.8	96.2
60	95.5	85.34	81.03	2.54 x 29 = 73.66	105.5	108.9
64	100.6	90.42	86.11	2.54 x 31 = 78.74	110.6	113.9

**Short levers**

for use with female connector without strain relief clamp

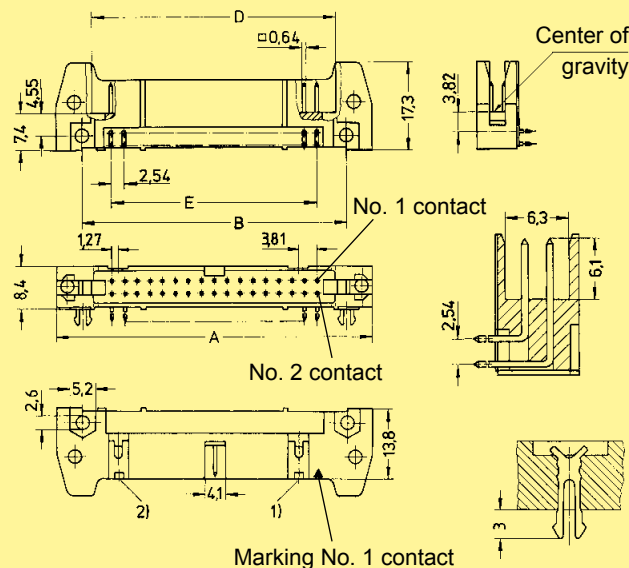

**Long levers**

for use with female connector with strain relief clamp

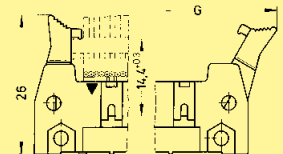

Board drillings

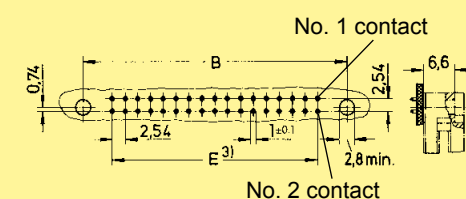

1) No polarization slot for 6, 10 or 14 way male header

2) No polarization slot for 6 way male header  
3) Pitch tolerance: ± 0.1

Number of contacts

# 6-64

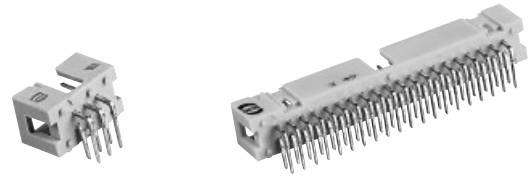

## Low-profile male header, angled solder pins

Identification      No. of contacts      Part No.      Drawing      Dimensions in mm

Male header with angled solder pins

Length: 2.9 mm

6	09 18 506	□ 323
10	09 18 510	□ 323
14	09 18 514	□ 323
16	09 18 516	□ 323
20	09 18 520	□ 323
26	09 18 526	□ 323
30	09 18 530	□ 323
34	09 18 534	□ 323
40	09 18 540	□ 323
50	09 18 550	□ 323
60	09 18 560	□ 323
64	09 18 564	□ 323

No. of contacts	A	B	E
6	15.2	12.78	2.54 x 2 = 5.08
10	20.3	17.86	2.54 x 4 = 10.16
14	25.4	22.94	2.54 x 6 = 15.24
16	27.9	25.48	2.54 x 7 = 17.78
20	33.0	30.56	2.54 x 9 = 22.86
26	40.6	38.18	2.54 x 12 = 30.48
30	45.72	43.26	2.54 x 14 = 35.56
34	50.8	48.34	2.54 x 16 = 40.64
40	58.4	55.96	2.54 x 19 = 48.26
50	71.3	68.66	2.54 x 24 = 60.96
60	84.0	81.36	2.54 x 29 = 73.66
64	89.1	86.44	2.54 x 31 = 78.74

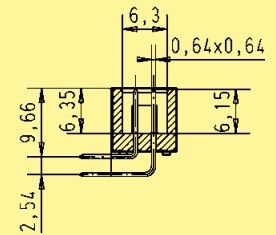

Solder pins for 1 ± 0.1 mm dia. hole

Marking No. 1 contact

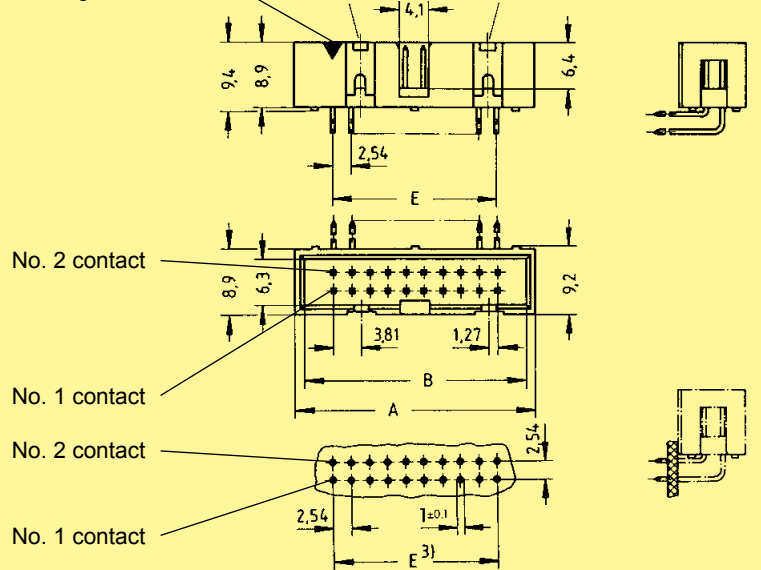

For performance level 3 please specify digit 7  
 For performance level 2 please specify digit 6  
 S4 = 0.76 µm (30 µinch) Au or PdNi equivalent



Identification      Part No.      Drawing      Dimensions in mm

Locking lever for female connector with strain relief

in conjunction with low-profile male header

When the security of latching is required and space is a premium, these locking levers can be fitted onto the strain relief of the HARTING female connector.

09 18 000 9905<sup>4)</sup>

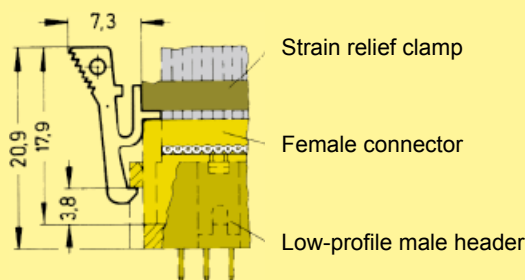

\* Not normally kept in stock

<sup>1)</sup> No polarization slot for 6, 10 or 14 way male header  
<sup>2)</sup> No polarization slot for 6 way male header

<sup>3)</sup> Pitch tolerance: ± 0.1  
<sup>4)</sup> Order 2 per female connector

Number of contacts

# 6-64



Low-profile male header, straight solder pins

Identification      No. of contacts      Part No.      Drawing      Dimensions in mm

Male header with straight solder pins

Length: 2.9 mm

6	09 18 506	324
10	09 18 510	324
14	09 18 514	324
16	09 18 516	324
20	09 18 520	324
26	09 18 526	324
30	09 18 530	324
34	09 18 534	324
40	09 18 540	324
50	09 18 550	324
60	09 18 560	324
64	09 18 564	324

No. of contacts	A	B	E
6	15.2	12.78	2.54 x 2 = 5.08
10	20.3	17.86	2.54 x 4 = 10.16
14	25.4	22.94	2.54 x 6 = 15.24
16	27.9	25.48	2.54 x 7 = 17.78
20	33.0	30.56	2.54 x 9 = 22.86
26	40.6	38.18	2.54 x 12 = 30.48
30	45.72	43.26	2.54 x 14 = 35.56
34	50.8	48.34	2.54 x 16 = 40.64
40	58.4	55.96	2.54 x 19 = 48.26
50	71.3	68.66	2.54 x 24 = 60.96
60	84.0	81.36	2.54 x 29 = 73.66
64	89.1	86.44	2.54 x 31 = 78.74

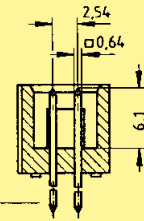

Solder pins for 1 ± 0.1 mm dia. hole

Male header with straight solder pins

Length: 4.5 mm

6	09 18 506	322*
10	09 18 510	322*
14	09 18 514	322*
16	09 18 516	322*
20	09 18 520	322*
26	09 18 526	322*
30	09 18 530	322*
34	09 18 534	322*
40	09 18 540	322*
50	09 18 550	322*
60	09 18 560	322*
64	09 18 564	322*

Marking No. 1 contact

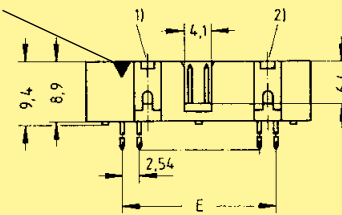

No. 2 contact

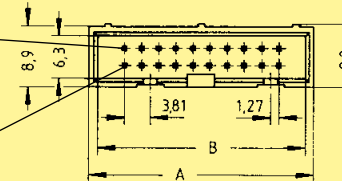

No. 1 contact

No. 2 contact

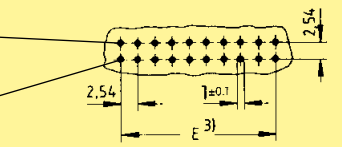

No. 1 contact

For performance level 3 please specify digit 7  
 For performance level 2 please specify digit 6  
 S4 = 0.76 µm (30 pinch) Au or PdNi equivalent



Identification

Part No.

Drawing

Dimensions in mm

Locking lever for female connector with strain relief

in conjunction with low-profile male header

When the security of latching is required and space is a premium, these locking levers can be fitted onto the strain relief of the HARTING female connector.

09 18 000 9905<sup>4)</sup>

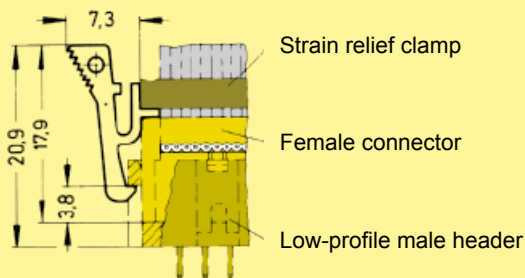

\* Not normally kept in stock

<sup>1)</sup> No polarization slot for 6, 10 or 14 way male header  
<sup>2)</sup> No polarization slot for 6 way male header

<sup>3)</sup> Pitch tolerance: ± 0.1  
<sup>4)</sup> Order 2 per female connector

Accessories

Identification	Part No.	Drawing	Dimensions in mm
<p>Polarization key</p> <p>1) Part No. comprises 2 keys</p>	<p>09 18 500 9902<sup>1)</sup></p>		
<p>Locking lever (snaps into place, can be fitted whenever required)</p> <p>2) Order 2 per male header</p>	<p>Long: 09 18 000 9903<sup>2)</sup></p> <p>Short: 09 18 000 9904<sup>2)</sup></p>	<p>Long</p> <p>Short</p> <p>For use with female connector <u>with</u> strain relief clamp</p> <p>For use with female connector <u>without</u> strain relief clamp</p>	
<p>Fixing screws for 1.6 mm P.C. board</p> <p>3) Part No. comprises 50 pieces</p>	<p>09 18 000 9906<sup>3)</sup></p>		
<p>Coding system with loss of contact</p> <p>4) Part No. comprises 6 code pins</p>	<p>Code pin 09 18 000 9901<sup>4)</sup></p> <p>Removal tool for male contacts 09 99 000 0133</p>	<p>To avoid cross-plugging adjacent connectors a coding system is required. A code pin is inserted into the appropriate cavity in the female connector. The corresponding male contact is removed by a special removal tool.</p>	

SEK



Number of contacts	6, 10, 14, 16, 20, 24, 26, 30, 34, 40, 50, 60, 64
Contact arrangement	straight, angled
Contact length	15 mm
Approvals	IEC 60 603-13 DIN EN 60 603-13 D 2632 BT 224 NFC 93-428 (HE 10)
Pitch	2.54 mm [0.100"]
Working current	1 A
Working voltage	500 V for pollution degree 1
Test voltage $U_{r.m.s.}$	1 kV
Contact resistance	$\leq 20 \text{ m}\Omega$
Insulation resistance	$\geq 10^9 \Omega$
Temperature range	-55 °C ... + 125 °C The maximum temperature includes heating of contacts and ambient temperature
Terminations	0.6 mm x 0.6 mm Diagonal: 0.86 mm
Materials	
Moulding	Thermoplastic resin (PBT) UL 94-V0
Contact surface	
Contact zone	plated according to performance level <sup>1)</sup>

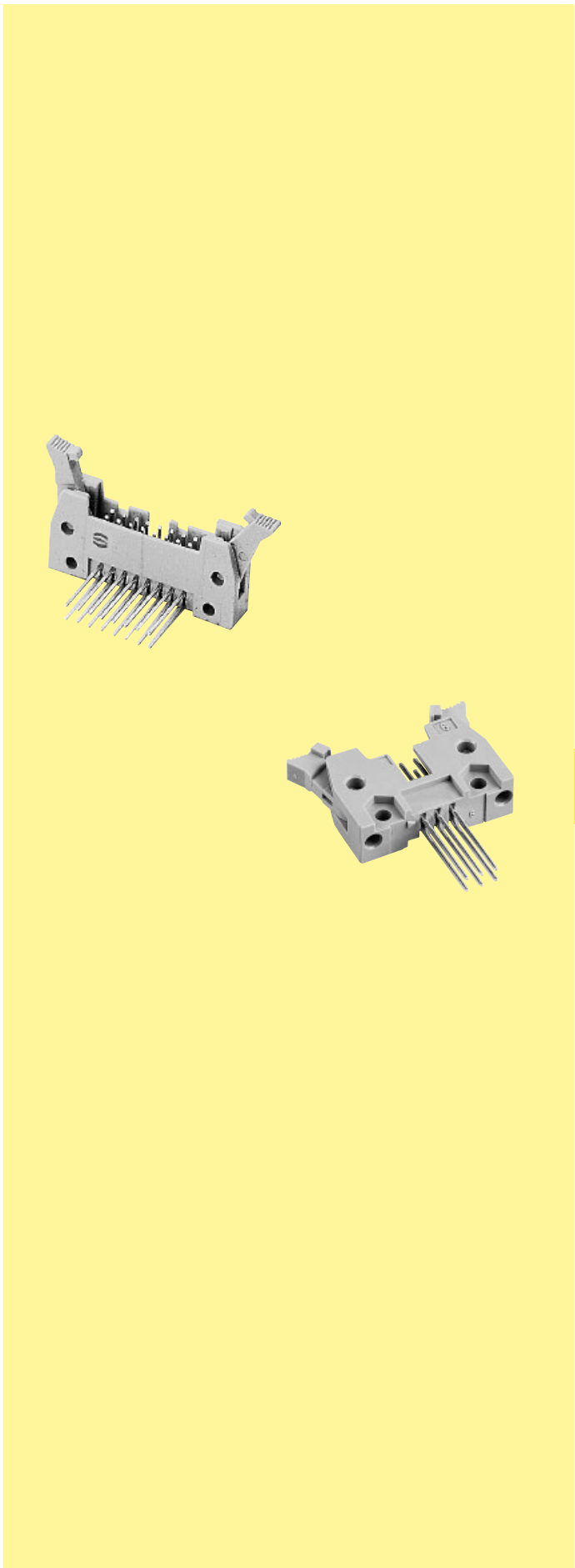

SEK

<sup>1)</sup> Performance level 3 as per IEC 60 603-13,  $\geq 50$  mating cycles, no gas test  
Performance level 2 as per IEC 60 603-13,  $\geq 250$  mating cycles, 4 days gas test  
S4, plating = 0.76  $\mu\text{m}$  (30  $\mu\text{inch}$ ) Au or PdNi equivalent

Number of contacts

6-64

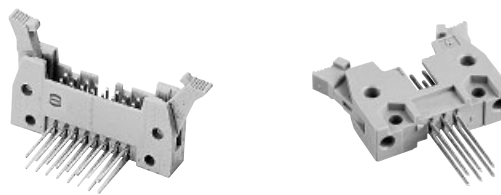

Male header with wrap posts

Identification	No. of contacts	Part No.						
		Without levers		With short levers		With long levers		
<b>Male header with angled wrap posts</b> Length: 15 mm □ 0.6 mm	6	09 18 506	└ 926*	09 18 506	└ 916*	09 18 506	└ 906*	
	10	09 18 510	└ 926*	09 18 510	└ 916*	09 18 510	└ 906*	
	14	09 18 514	└ 926*	09 18 514	└ 916*	09 18 514	└ 906*	
	16	09 18 516	└ 926*	09 18 516	└ 916*	09 18 516	└ 906*	
	20	09 18 520	└ 926*	09 18 520	└ 916*	09 18 520	└ 906*	
	24	09 18 524	└ 926*	09 18 524	└ 916*	09 18 524	└ 906*	
	26	09 18 526	└ 926*	09 18 526	└ 916*	09 18 526	└ 906*	
	30	09 18 530	└ 926*	09 18 530	└ 916*	09 18 530	└ 906*	
	34	09 18 534	└ 926*	09 18 534	└ 916*	09 18 534	└ 906*	
	40	09 18 540	└ 926*	09 18 540	└ 916*	09 18 540	└ 906*	
	50	09 18 550	└ 926*	09 18 550	└ 916*	09 18 550	└ 906*	
	60	09 18 560	└ 926*	09 18 560	└ 916*	09 18 560	└ 906*	
	64	09 18 564	└ 926*	09 18 564	└ 916*	09 18 564	└ 906*	
	<b>Male header with straight wrap posts</b> Length: 15 mm □ 0.6 mm	6	09 18 506	└ 927*	09 18 506	└ 917*	09 18 506	└ 907*
		10	09 18 510	└ 927*	09 18 510	└ 917*	09 18 510	└ 907*
14		09 18 514	└ 927*	09 18 514	└ 917*	09 18 514	└ 907*	
16		09 18 516	└ 927*	09 18 516	└ 917*	09 18 516	└ 907*	
20		09 18 520	└ 927*	09 18 520	└ 917*	09 18 520	└ 907*	
24		09 18 524	└ 927*	09 18 524	└ 917*	09 18 524	└ 907*	
26		09 18 526	└ 927*	09 18 526	└ 917*	09 18 526	└ 907*	
30		09 18 530	└ 927*	09 18 530	└ 917*	09 18 530	└ 907*	
34		09 18 534	└ 927*	09 18 534	└ 917*	09 18 534	└ 907*	
40		09 18 540	└ 927*	09 18 540	└ 917*	09 18 540	└ 907*	
50		09 18 550	└ 927*	09 18 550	└ 917*	09 18 550	└ 907*	
60		09 18 560	└ 927*	09 18 560	└ 917*	09 18 560	└ 907*	
64		09 18 564	└ 927*	09 18 564	└ 917*	09 18 564	└ 907*	

SEK

\* Not normally kept in stock  
 For accessories see page 09.20  
 For dimensions see page 09.19

For performance level 3 please specify digit  
 For performance level 2 please specify digit  
 S4 = 0.76 µm (30 µinch) Au or PdNi equivalent

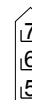
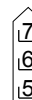
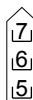

Number of contacts

# 6-64

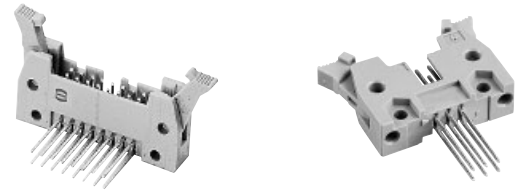

Male header with wrap posts

Identification

Drawing

Dimensions in mm

Male header

No. of contacts	A	B	C	D	E	F	G
6	26.9	16.76	22.86	12.45	2.54 x 2 = 5.08	36.9	40.3
10	32.0	21.84	27.94	17.53	2.54 x 4 = 10.16	42.0	45.4
14	37.1	26.92	33.02	22.61	2.54 x 6 = 15.24	47.1	50.4
16	39.6	29.46	35.56	25.15	2.54 x 7 = 17.78	49.6	53.0
20	44.7	34.54	40.64	30.23	2.54 x 9 = 22.86	54.7	58.1
24	49.8	39.62	45.72	35.91	2.54 x 11 = 27.94	59.8	63.2
26	52.3	42.16	48.26	37.85	2.54 x 12 = 30.48	62.3	65.7
30	57.7	47.24	53.43	43.83	2.54 x 14 = 35.56	68.2	68.6
34	62.5	52.32	58.42	48.01	2.54 x 16 = 40.64	72.5	75.8
40	70.1	59.94	66.04	55.63	2.54 x 19 = 48.26	80.1	83.5
50	82.8	72.64	78.74	68.33	2.54 x 24 = 60.96	92.8	96.2
60	95.5	85.34	91.44	81.03	2.54 x 29 = 73.66	105.5	108.9
64	100.6	90.42	96.52	86.11	2.54 x 31 = 78.74	110.6	113.9

Long levers

for use with female connector with strain relief clamp

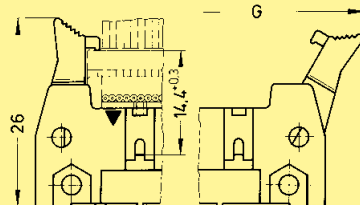

Short levers

for use with female connector without strain relief clamp

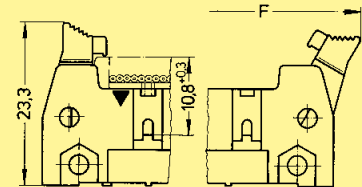

Angled versions

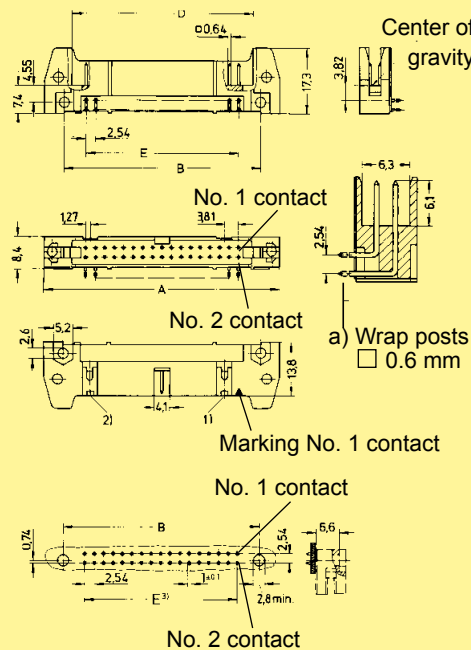

Straight versions

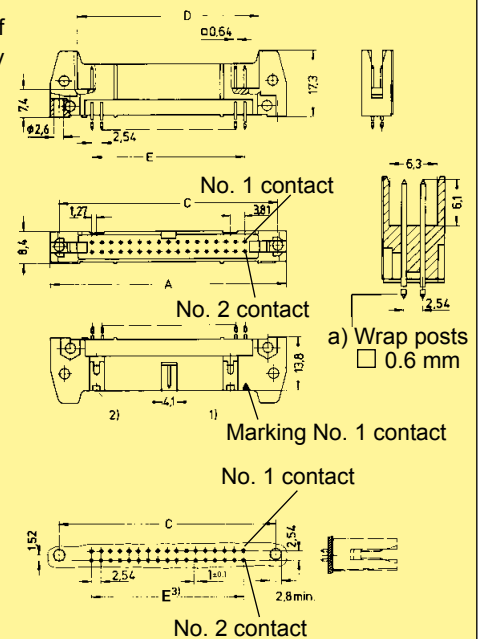

Board drillings

<sup>1)</sup> No polarization slot for 6, 10 or 14 way male header

<sup>2)</sup> No polarization slot for 6 way male header

<sup>3)</sup> Pitch tolerance: ± 0.1

Accessories

Identification	Part No.	Drawing	Dimensions in mm
<p>Polarization key</p> <p>1) Part No. comprises 2 keys</p>	<p>09 18 500 9902<sup>1)</sup></p>		
<p>Locking lever (snaps into place, can be fitted whenever required)</p> <p>2) Order 2 per male header</p>	<p>Long: 09 18 000 9903<sup>2)</sup></p> <p>Short: 09 18 000 9904<sup>2)</sup></p>	<p>Long</p> <p>Short</p> <p>For use with female connector <u>with</u> strain relief clamp</p> <p>For use with female connector <u>without</u> strain relief clamp</p>	
<p>Fixing screws for 1.6 mm P.C. board</p> <p>3) Part No. comprises 50 pieces</p>	<p>09 18 000 9906<sup>3)</sup></p>		
<p>Coding system with loss of contact</p> <p>4) Part No. comprises 6 code pins</p>	<p>Code pin 09 18 000 9901<sup>4)</sup></p> <p>Removal tool for male contacts 09 99 000 0133</p>	<p>To avoid cross-plugging adjacent connectors a coding system is required. A code pin is inserted into the appropriate cavity in the female connector. The corresponding male contact is removed by a special removal tool.</p>	

SEK

Number of contacts 6, 10, 14, 16, 20, 24, 26, 30, 34, 40, 50, 60, 64

Approvals IEC 60 603-13  
DIN EN 60 603-13  
D 2632  
BT 224  
NFC 93-428 (HE 10)  
UL recognized: E102079



Pitch 2.54 mm [0.100"]

Working current 1 A

Working voltage 320 V  
for pollution degree 1

Test voltage  $U_{r.m.s.}$  1 kV

Contact resistance  $\leq 20 \text{ m}\Omega$   
Insulation resistance  $\geq 10^9 \Omega$

Temperature range -55 °C ... + 125 °C  
The maximum temperature includes heating of contacts and ambient temperature

Terminations IDC flat cable  
1.27 mm [0.050"] pitch:  
AWG 26/7 – AWG 28/7

Materials Moulding Thermoplastic resin (PBT)  
UL 94-V0

Contact surface Contact zone gold-plated according to performance level<sup>1)</sup>

### Current carrying capacity

The current carrying capacity is limited by maximum temperature of materials for inserts and contacts including terminals. The current capacity-curve is valid for continuous, not interrupted current-loaded contacts of connectors when simultaneous power on all contacts is given, without exceeding the maximum temperature.

Control and test procedures according to DIN IEC 60 512.

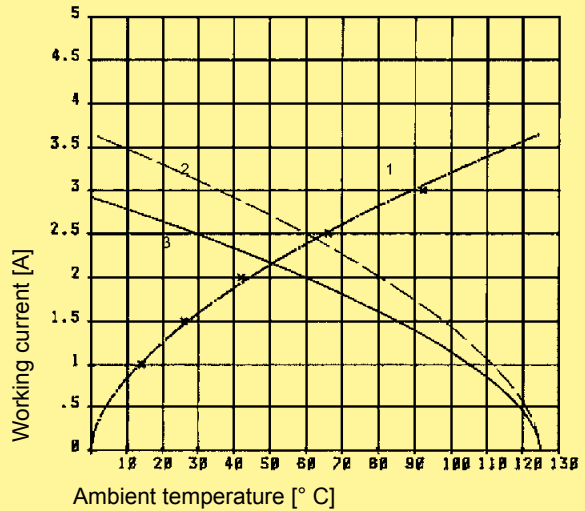

Example: 50 way connector

- ① Temperature rise
- ② Derating
- ③ Derating curve at  $I_{max} \times 0.8$  (IEC 60 512-2)

### Insertion and withdrawal forces

Number of contacts	Maximum force [N]	
	Performance level 1 and 2	Performance level 3
6	12	18
10	20	30
14	28	42
16	32	48
20	40	60
24	48	72
26	52	78
30	60	90
34	68	102
40	80	120
50	100	150
60	120	180
64	128	192

<sup>1)</sup> Performance level 3 as per IEC 60 603-13,  $\geq 50$  mating cycles, no gas test  
Performance level 2 as per IEC 60 603-13,  $\geq 250$  mating cycles, 4 days gas test  
S4, plating = 0.76  $\mu\text{m}$  (30  $\mu\text{inch}$ ) Au or PdNi equivalent

Number of contacts

# 6-64

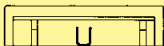
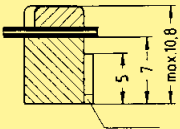
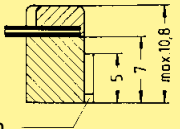
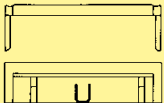

## Female connector

Identification	No. of contacts	Part No.		Drawing	Dimensions in mm	
<b>Female connector with central polarization</b> without strain relief clamp 		open end cover	closed end cover	open end cover	closed end cover	
						
	6	09 18 506 □ 803	09 18 506 □ 804			
	10	09 18 510 □ 803	09 18 510 □ 804			
	14	09 18 514 □ 803	09 18 514 □ 804			
	16	09 18 516 □ 803	09 18 516 □ 804			
	20	09 18 520 □ 803	09 18 520 □ 804			
	24	09 18 524 □ 803	09 18 524 □ 804			
	26	09 18 526 □ 803	09 18 526 □ 804			
	30	09 18 530 □ 803	09 18 530 □ 804			
	34	09 18 534 □ 803	09 18 534 □ 804			
	40	09 18 540 □ 803	09 18 540 □ 804			
	50	09 18 550 □ 803	09 18 550 □ 804			
	60	09 18 560 □ 803	09 18 560 □ 804			
	64	09 18 564 □ 803	09 18 564 □ 804			
	without strain relief clamp with bulk packaging 2) Packaging unit (PU) 5,000 pieces 3) PU 3,000 pieces	6	09 18 506 □ 803 58U <sup>2)</sup>			
		10	09 18 510 □ 803 58U <sup>2)</sup>			
		14	09 18 514 □ 803 58U <sup>2)</sup>			
		16	09 18 516 □ 803 58U <sup>2)</sup>			
		20	09 18 520 □ 803 58U <sup>2)</sup>			
26		09 18 526 □ 803 58U <sup>2)</sup>				
30		09 18 530 □ 803 58U <sup>2)</sup>				
40		09 18 540 □ 803 58U <sup>3)</sup>				
with strain relief clamp 	6	09 18 506 □ 813	09 18 506 □ 814*			
	10	09 18 510 □ 813	09 18 510 □ 814*			
	14	09 18 514 □ 813	09 18 514 □ 814*			
	16	09 18 516 □ 813	09 18 516 □ 814*			
	20	09 18 520 □ 813	09 18 520 □ 814*			
	24	09 18 524 □ 813				
	26	09 18 526 □ 813	09 18 526 □ 814*			
	30	09 18 530 □ 813	09 18 530 □ 814*			
	34	09 18 534 □ 813	09 18 534 □ 814*			
	40	09 18 540 □ 813	09 18 540 □ 814*			
	50	09 18 550 □ 813	09 18 550 □ 814*			
	60	09 18 560 □ 813	09 18 560 □ 814*			
	64	09 18 564 □ 813	09 18 564 □ 814*			
	with strain relief clamp with bulk packaging 3) Packaging unit (PU) 3,000 pieces 4) PU 2,500 pieces 5) PU 2,000 pieces 6) PU 1,500 pieces 7) PU 1,000 pieces	6	09 18 506 □ 813 58U <sup>3)</sup>			
		10	09 18 510 □ 813 58U <sup>3)</sup>			
		14	09 18 514 □ 813 58U <sup>4)</sup>			
16		09 18 516 □ 813 58U <sup>4)</sup>				
20		09 18 520 □ 813 58U <sup>5)</sup>				
26		09 18 526 □ 813 58U <sup>6)</sup>				
30		09 18 530 □ 813 58U <sup>5)</sup>				
40		09 18 540 □ 813 58U <sup>7)</sup>				

  

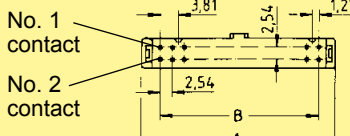

No. 1 contact

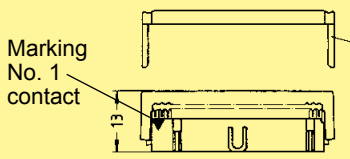

No. 2 contact

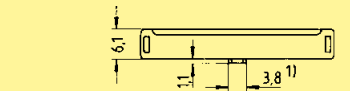

Strain relief clamp option

No. of contacts	6	10	14	16	20
A	12.20	17.30	22.40	24.90	30.00
B	5.08	10.16	15.24	17.78	22.86



  

No. of contacts	24	26	30	34	40
A	35.18	37.60	42.70	47.80	55.40
B	27.94	30.48	35.56	40.64	48.26

No. of contacts	50	60	64		
A	68.10	80.80	85.90		
B	60.96	73.66	78.74		

SEK

For performance level 3 please specify digit   
 For performance level 2 please specify digit   
 S4 = 0.76 μm (30 μinch) Au or PdNi equivalent

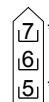

<sup>1)</sup> Pitch tolerance: ± 0.1  
 \* Not normally kept in stock

Number of contacts

**6-64**



Strain relief clamp/Locking lever

Identification      No. of contacts      Part No.      Drawing      Dimensions in mm

Strain relief clamp

6	09 18 506 9002
10	09 18 510 9002
14	09 18 514 9002
16	09 18 516 9002
20	09 18 520 9002
24	09 18 524 9002
26	09 18 526 9002
30	09 18 530 9002
34	09 18 534 9002
40	09 18 540 9002
50	09 18 550 9002
60	09 18 560 9002
64	09 18 564 9002

No. of contacts	A
6	12.2
10	17.3
14	22.4
16	24.9
20	30.0
24	35.18
26	37.6
30	42.7
34	47.8
40	55.4
50	68.1
60	80.8
64	85.9

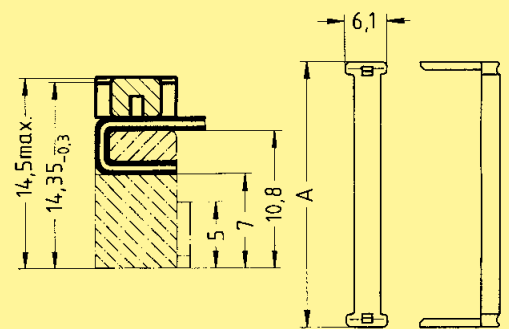

with bulk packaging

6	09 18 506 9002 58U <sup>3)</sup>
10	09 18 510 9002 58U <sup>3)</sup>
14	09 18 514 9002 58U <sup>3)</sup>
16	09 18 516 9002 58U <sup>3)</sup>
20	09 18 520 9002 58U <sup>3)</sup>
26	09 18 526 9002 58U <sup>3)</sup>
30	09 18 530 9002 58U <sup>3)</sup>
34	09 18 534 9002 58U <sup>4)</sup>
40	09 18 540 9002 58U <sup>4)</sup>

<sup>3)</sup> Packaging unit 5,000 pieces  
<sup>4)</sup> Packaging unit 3,000 pieces

Locking lever for female connector  
Only in conjunction with low-profile male header and strain relief

09 18 000 9905<sup>1)5)</sup>  
09 18 000 9905 58U<sup>1)6)</sup>

<sup>5)</sup> Packaging unit 100 pieces  
<sup>6)</sup> Packaging unit 5,000 pieces

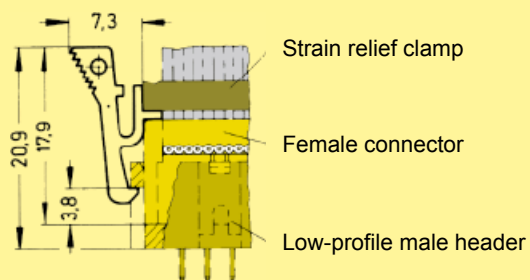

When the security of latching is required and space is a premium, these locking levers can be fitted onto the strain relief of the HARTING female connector. This can then be used in conjunction with male low-profile headers (see pages 09.14 and 09.15).

Coding system with loss of contact

Code pin

09 18 000 9901<sup>2)</sup>

Removal tool for male contacts

09 99 000 0133

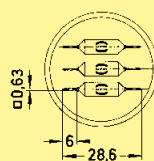

To avoid cross-plugging adjacent connectors a coding system is required. A code pin is inserted into the appropriate cavity in the female connector. The corresponding male contact is removed by a special removal tool.



<sup>1)</sup> Order 2 per female connector  
<sup>2)</sup> Part No. comprises 6 code pins

Number of contacts 4, 6, 8, 10, 14, 16, 20, 24, 26, 30, 34, 40, 50, 60, 64

Pitch  
On pcb side: 2.54 mm [0.100"]  
On cable side: 1.27 mm [0.050"]

Working current 1 A

Test voltage  $U_{r.m.s.}$  1 kV AC – 1 minute

Contact resistance 35 m $\Omega$  max.  
Insulation resistance  $\geq 10^9 \Omega$

Temperature range -55 °C ... + 105 °C  
The maximum temperature includes heating of contacts and ambient temperature

Terminations  
Solder pins:  
0.635 mm x 0.3 mm  
Dimensions for pcb hole:  
Standard version:  $\varnothing 0.9^{\pm 0.10}$  mm  
Kinked version:  $\varnothing 1.0^{\pm 0.05}$  mm  
Diagonal: 0.71 mm  
IDC flat cable  
1.27 mm [0.050"] pitch: AWG 28/7

Materials  
Moulding Thermoplastic resin (PBT)  
UL 94-V0

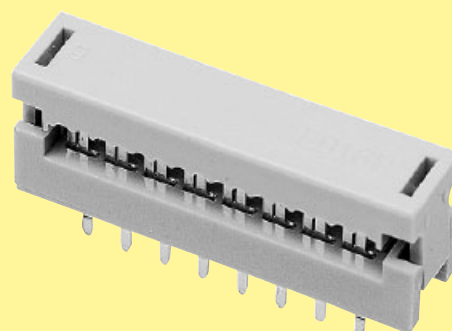
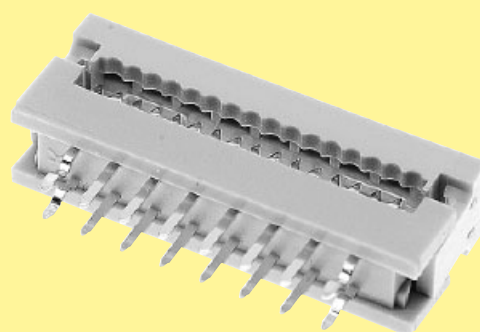



Number of contacts

4-64

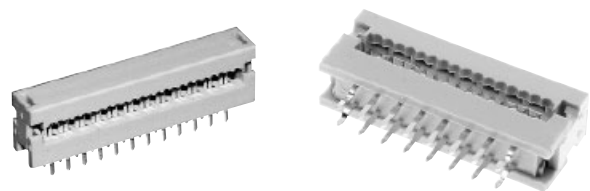

Pcb transition connector, 2 rows, low-profile with 5.5 mm height

Identification      No. of contacts      Part No.      Drawing      Dimensions in mm

Pcb transition connector<sup>2)</sup>  
2 rows  
Standard low-profile version

4	09 18 104 9622
6	09 18 106 9622
8	09 18 108 9622
10	09 18 110 9622
14	09 18 114 9622
16	09 18 116 9622
20	09 18 120 9622
24	09 18 124 9622
26	09 18 126 9622
30	09 18 130 9622
34	09 18 134 9622
40	09 18 140 9622
50	09 18 150 9622
60	09 18 160 9622
64	09 18 164 9622

No. of contacts	A±0.38	B±0.10
4	10.38	2.54 x 1 = 2.54
6	12.92	2.54 x 2 = 5.08
8	15.46	2.54 x 3 = 7.62
10	18.00	2.54 x 4 = 10.16
14	23.08	2.54 x 6 = 15.24
16	25.62	2.54 x 7 = 17.78
20	30.74	2.54 x 9 = 22.86
24	35.78	2.54 x 11 = 27.94
26	38.32	2.54 x 12 = 30.48
30	43.40	2.54 x 14 = 35.56
34	48.48	2.54 x 16 = 40.64
40	56.10	2.54 x 19 = 48.26
50	68.80	2.54 x 24 = 60.96
60	81.50	2.54 x 29 = 73.66
64	86.58	2.54 x 31 = 78.74

Pcb transition connector<sup>2)</sup>  
2 rows  
Kinked low-profile version  
2 kinked pins at each extremity

4	09 18 104 9422
6	09 18 106 9422
8	09 18 108 9422
10	09 18 110 9422
14	09 18 114 9422
16	09 18 116 9422
20	09 18 120 9422
24	09 18 124 9422
26	09 18 126 9422
30	09 18 130 9422
34	09 18 134 9422
40	09 18 140 9422
50	09 18 150 9422
60	09 18 160 9422
64	09 18 164 9422

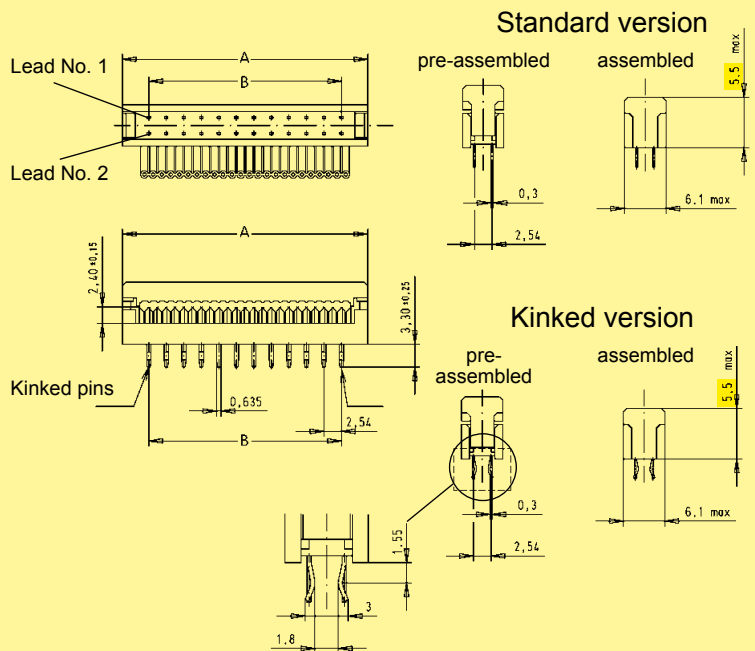

Board drillings

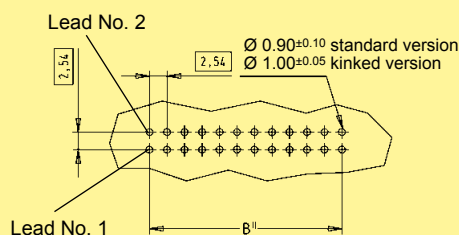

1) Pitch tolerance: ± 0.05  
2) Not released for halogen free flat cables

Number of contacts\* 10, 16, 20, 26, 34, 40, 50

Pitch  
On pcb side: 2.54 mm [0.100"]  
On cable side: 1.27 mm [0.050"]

Working current 1 A

Test voltage  $U_{r.m.s.}$  500 V

Contact resistance  $\leq 20 \text{ m}\Omega$   
Insulation resistance  $\geq 10^{12} \Omega$

Temperature range -40 °C ... + 125 °C  
The maximum temperature includes heating of contacts and ambient temperature

Terminations  
Solder pins  
0.45 mm x 0.35 mm  
for pcb hole  $\varnothing$  0.8 mm  
Diagonal: 0.58 mm  
IDC flat cable  
1.27 mm [0.050"] pitch:  
AWG 26/7 – AWG 28/7 – AWG 30/1

Materials  
Moulding Thermoplastic resin (PC)  
UL 94-V0

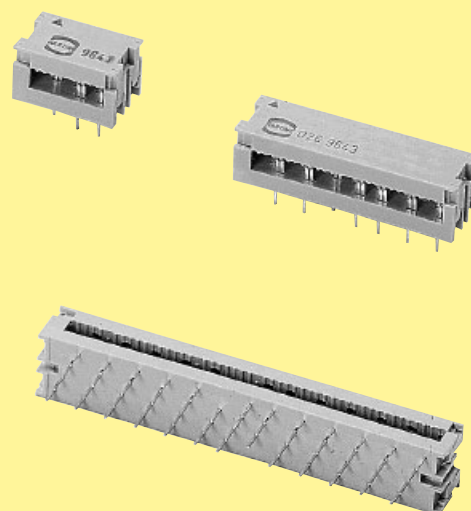

Number of contacts

10-50



Pcb transition connector, 4 rows

Identification      No. of contacts      Part No.      Drawing      Dimensions in mm

Pcb transition connector<sup>2)</sup>  
4 rows

10	09 19 010 9643*
16	09 19 016 9643*
20	09 19 020 9643*
26	09 19 026 9643*
34	09 19 034 9643*
40	09 19 040 9643*
50	09 19 050 9643*

No. of contacts	A	B
10	17.78	1.27 x 9 = 11.43
16	25.40	1.27 x 15 = 19.05
20	30.48	1.27 x 19 = 24.13
26	38.10	1.27 x 25 = 31.75
34	48.26	1.27 x 33 = 41.91
40	55.88	1.27 x 39 = 49.53
50	68.58	1.27 x 49 = 62.23

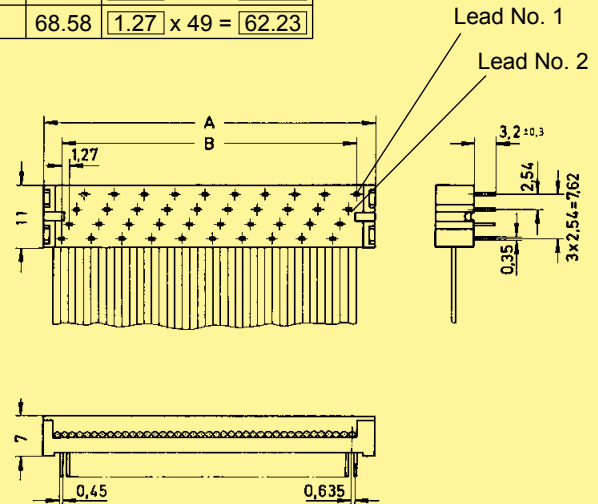

Board drillings

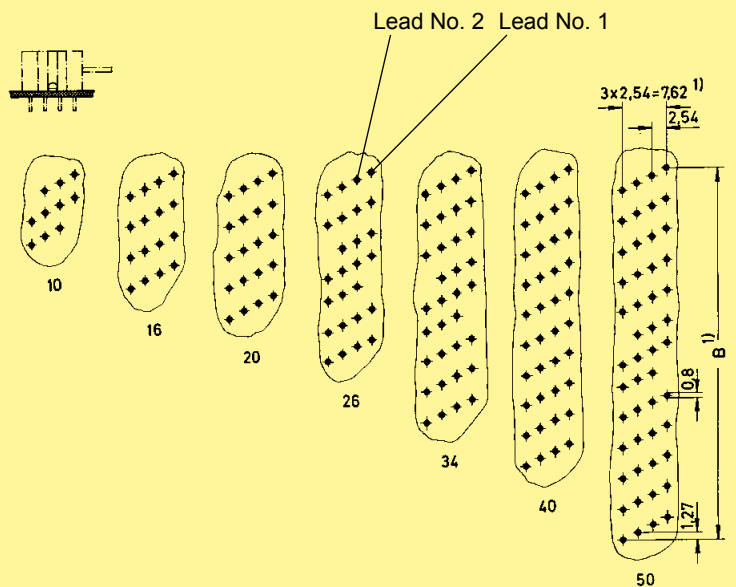

\* Not normally kept in stock

<sup>1)</sup> Pitch tolerance: ± 0.1

<sup>2)</sup> Not released for halogen free flat cables

Number of contacts*	14, 16, 24, 28, 40
Pitch	On pcb side: 2.54 mm [0.100"] On cable side: 1.27 mm [0.050"]
Working current	1 A
Test voltage $U_{r.m.s.}$	500 V
Contact resistance	$\leq 20 \text{ m}\Omega$
Insulation resistance	$\geq 10^{12} \Omega$
Temperature range	-40 °C ... + 125 °C The maximum temperature includes heating of contacts and ambient temperature
Terminations	Solder pins 0.45 mm x 0.35 mm for pcb hole $\varnothing$ 0.8 mm Diagonal: 0.58 mm IDC flat cable 1.27 mm [0.050"] pitch: AWG 28/7
Materials Moulding	Thermoplastic resin (PC) UL 94-V0

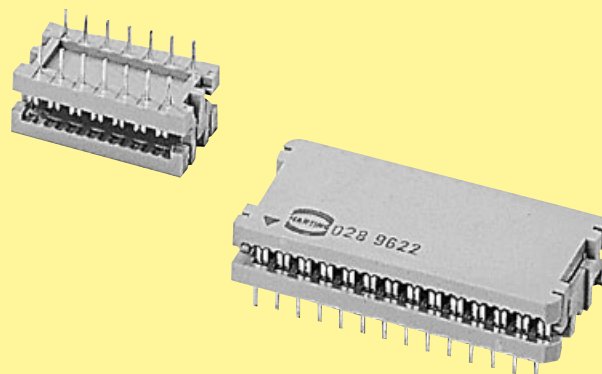

Number of contacts

# 14-40

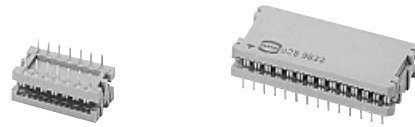

DIP connector for IC base or for soldering into pcb

Identification      No. of contacts      Part No.      Drawing      Dimensions in mm

DIP connector<sup>2)</sup>

14	09 17 014 9622*
16	09 17 016 9622*
24	09 17 024 9622*
28	09 17 028 9622*
40	09 17 040 9622*

No. of contacts	A	B	C	D
14	20.5	2.54 x 6 = 15.24	11	7.62
16	23.0	2.54 x 7 = 17.78	11	7.62
24	33.0	2.54 x 11 = 27.94	18.7	15.24
28	38.1	2.54 x 13 = 33.02	18.7	15.24
40	53.3	2.54 x 19 = 48.26	18.7	15.24

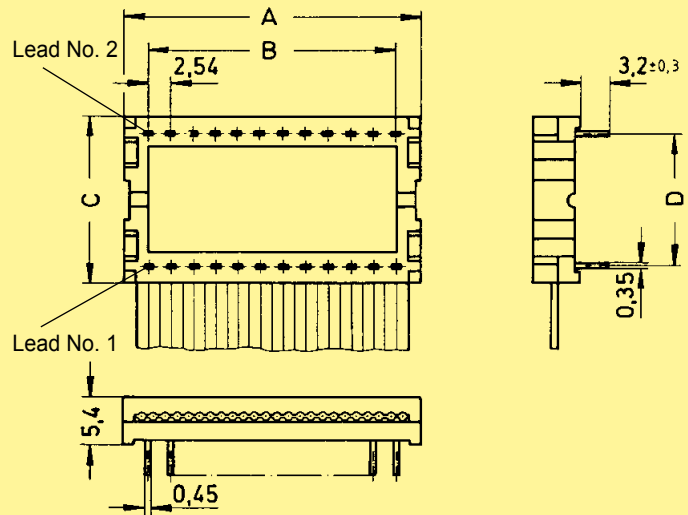

Board drillings

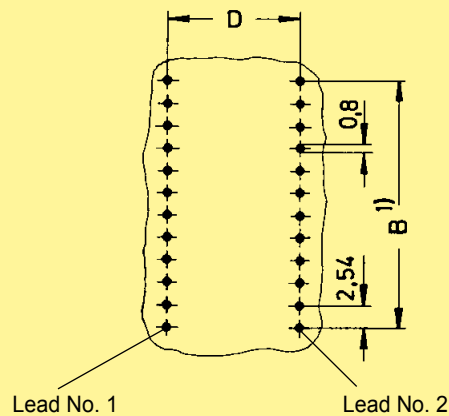
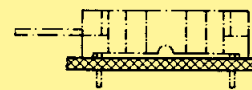

SEK

\* Not normally kept in stock  
 1) Pitch tolerance: ± 0.1  
 2) Not released for halogen free flat cables

Number of contacts 64

Pitch 2.54 mm [0.100"]

Working current 1 A max.

Clearance  $\geq 1.2$  mm  
Creepage  $\geq 1.2$  mm

**Working voltage**  
The working voltage also depends on the clearance and creepage dimensions of the pcb itself, and the associated wiring according to the safety regulations of the equipment

Test voltage  $U_{r.m.s.}$  1 kV

Contact resistance  $\leq 20$  m $\Omega$   
Insulation resistance  $\geq 10^{12}$   $\Omega$

Temperature range -55 °C ... + 125 °C  
The maximum temperature includes heating of contacts and ambient temperature

**Termination**  
Female connector Insulation displacement: AWG 28/7

Insertion and withdrawal force  $\leq 60$  N

**Materials**  
Moulding Thermoplastic resin, glass-fibre filled, UL 94-V0  
Contacts Copper alloy

**Contact surface**  
Contact zone selectively plated according to performance level

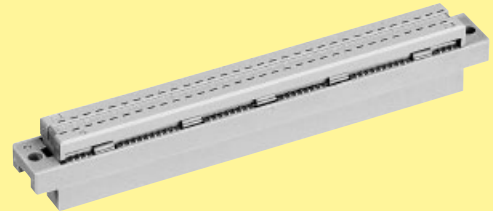
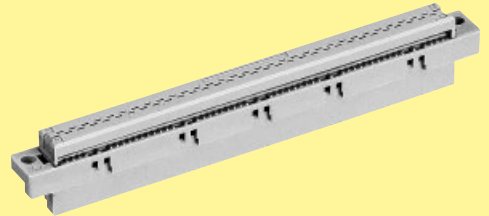

Number of contacts

64

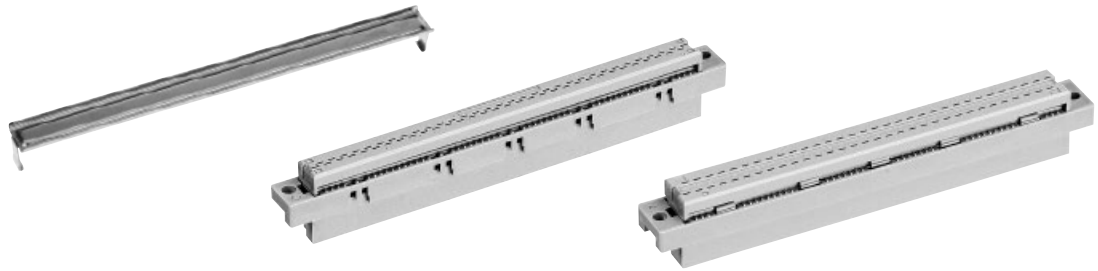

Female connectors for insulation displacement

Identification	No. of contacts	Part No.	Drawing	Dimensions in mm
----------------	-----------------	----------	---------	------------------

Female connector for insulation displacement

Type B

64

performance level 2

09 02 264 6828

performance level 3

09 02 264 7828

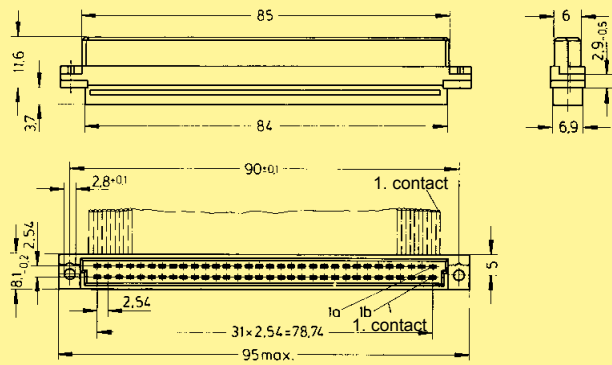

Lead number 1 of flat cable on contact 1 b

Contact arrangement View from termination side

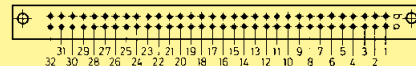

Type C

64

performance level 2

09 03 264 6828

09 03 764 6828<sup>c)</sup>

performance level 3

09 03 264 7828

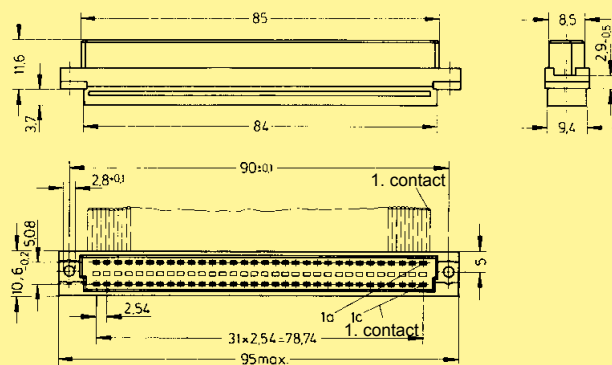

Lead number 1 of flat cable on contact 1 c

Contact arrangement View from termination side

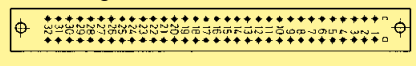

Mateable with 3-row male connector Type C.  
No female contact in middle row.

Panel cut out

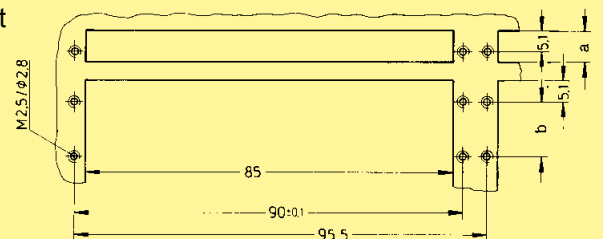

	a	b
Type B	8.3	10.16
Type C	10.8	12.7

Strain relief for types B and C

09 03 000 9940

SEK

