

Number of contacts

6-64

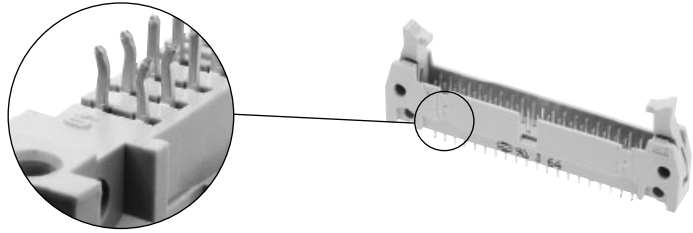

SMC male header with straight solder pins, kinked

Identification

Drawing

Dimensions in mm

SMC male header

No. of contacts	A	C	D	E	F	G
6	26.9	22.86	12.45	2.54 x 2 = 5.08	36.9	40.3
10	32.0	27.94	17.53	2.54 x 4 = 10.16	42.0	45.4
14	37.1	33.02	22.61	2.54 x 6 = 15.24	47.1	50.4
16	39.6	35.56	25.15	2.54 x 7 = 17.78	49.6	53.0
20	44.7	40.64	30.23	2.54 x 9 = 22.86	54.7	58.1
24	49.8	45.72	35.91	2.54 x 11 = 27.94	59.8	63.2
26	52.3	48.26	37.85	2.54 x 12 = 30.48	62.3	65.7
30	57.7	53.34	43.83	2.54 x 14 = 35.56	68.2	68.6
34	62.5	58.42	48.01	2.54 x 16 = 40.64	72.5	75.8
40	70.1	66.04	55.63	2.54 x 19 = 48.26	80.1	83.5
50	82.8	78.74	68.33	2.54 x 24 = 60.96	92.8	96.2
60	95.5	91.44	81.03	2.54 x 29 = 73.66	105.5	108.9
64	100.6	96.52	86.11	2.54 x 31 = 78.74	110.6	113.9

Short levers

for use with female connector without strain relief clamp

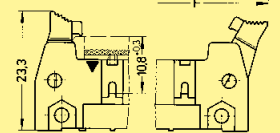
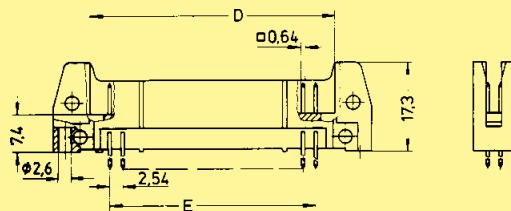

Long levers

for use with female connector with strain relief clamp

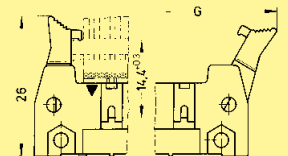
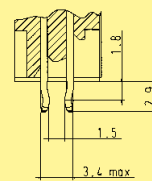
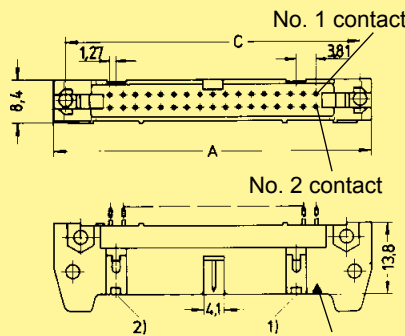

Marking No. 1 contact

No. 1 contact

Board drillings

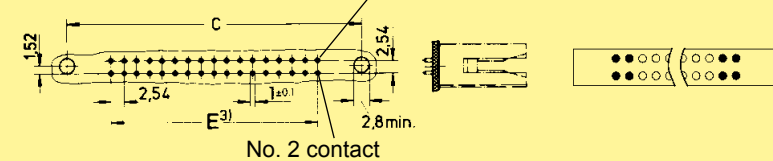

● Kinked contact: pcb thickness from 1.50 to 1.94 mm after Cu + Sn plating with non-remelted through holes \varnothing 0.80 to \varnothing 0.95 mm. Max. insertion force = 125 N. Min. retention force = 6 N.

○ Non-kinked contact: Solder pins for pcb connections \varnothing 1 ± 0.1 mm as per IEC 60603-13.

1) No polarization slot for 6, 10 or 14 way male header

2) No polarization slot for 6 way male header

3) Pitch tolerance: ± 0.1